



CARIBBEAN
EXAMINATIONS
COUNCIL

Caribbean Secondary
Education Certificate®

SYLLABUS

TECHNICAL DRAWING

CXC 13/G/SYLL 15

Effective for examinations from May–June 2017

Correspondence related to the syllabus should be addressed to:

The Pro-Registrar
Caribbean Examinations Council
Caenwood Centre
37 Arnold Road, Kingston 5, Jamaica

Telephone Number: + 1 (876) 630-5200
Facsimile Number: + 1 (876) 967-4972
E-mail Address: cxcwzo@cxc.org
Website: www.cxc.org

Copyright ©2017 by Caribbean Examinations Council
Prince Road, Pine Plantation Road, St Michael BB11091

NOTE TO TEACHERS AND LEARNERS

This document CXC 13/G/SYLL/ 15 replaces CXC 13/G/SYLL 10 issued in 2010.

Please note that the syllabus has been revised and amendments are indicated by italics.

First issued 2000

Revised 2010

Revised 2015

Please check the website, www.cxc.org for updates on CXC's syllabuses.

PLEASE NOTE



This icon is used throughout the syllabus to represent key features which teachers and learners may find useful.

Contents

RATIONALE	1
AIMS	2
ORGANISATION OF THE SYLLABUS	2
RECOMMENDED TEACHING APPROACH.....	2
SUGGESTED TIMETABLE ALLOCATION	3
CERTIFICATION.....	3
DEFINITION OF PROFILE DIMENSIONS.....	4
<i>CERTIFICATION AND DEFINITION OF PROFILE</i>	4
<i>FORMAT OF THE EXAMINATION</i>	4
WEIGHTING OF PAPERS AND PROFILES	5
COMPOSITION OF PAPERS BY SECTIONS	6
REGULATIONS FOR PRIVATE CANDIDATES	6
REGULATIONS FOR RESIT CANDIDATES	6
RECOMMENDED MINIMUM EQUIPMENT AND MATERIAL FOR TECHNICAL DRAWING SYLLABUS	7
COMPUTER-AIDED DRAFTING METHOD	7
<i>SECTION 1 – FUNDAMENTALS OF TECHNICAL DRAWING</i> <i>1A – OCCUPATIONAL HEALTH, SAFETY AND THE ENVIRONMENT</i>	9
<i>SECTION 1B – EQUIPMENT, TOOLS, MATERIALS, LETTERING, LINE WORK, DIMENSIONS AND SCALES)</i>	13
<i>SECTION 2A – GEOMETRICAL CONSTRUCTION: PLANE GEOMETRY</i>	20
<i>SECTION 2B – GEOMETRICAL CONSTRUCTION: SOLID GEOMETRY</i>	26
<i>SECTION 3A – BUILDING DRAWING</i>	32
<i>SECTION 4 – MECHANICAL ENGINEERING DRAWING</i>	40
<i>SUGGESTED TEACHING AND LEARNING ACTIVITIES</i>	50

<i>GUIDELINES FOR THE SCHOOL-BASED ASSESSMENT</i>	51
<i>SUGGESTED ACTIVITIES FOR THE SBA</i>	52
<i>EXEMPLARS</i>	55
RESOURCES	65
GLOSSARY OF TERMS	66
APPENDIX I – SCHOOL-BASED ASSESSMENT MARK SCHEME.....	70
APPENDIX II – PORTFOLIO DEVELOPMENT GUIDELINES	75
APPENDIX III – GUIDELINES FOR THE DELIVERY AND ASSESSMENT OF THE SCHOOL-BASED ASSESSMENT USING THE PRINCIPLES OF COMPETENCY-BASED EDUCATION, TRAINING AND ASSESSMENT (CBETA)	77

Technical Drawing Syllabus

◆ RATIONALE

Technical Drawing is a visual means of communicating clearly and concisely all the information (drawings, dimensions, notes, specifications) necessary to transfer an idea or concept into reality. It is based on the principles of projection in two-dimensional and three-dimensional representations. Technical Drawing has its most common application in the field of manufacturing, engineering, architecture and construction where it is used to document and support the design process. This is accomplished by communicating ideas about the shape, form, dimensions, materials, manufacturing methods and finishes of articles to be produced. Technical Drawing plays an indispensable role in determining the quality and competitiveness of finished products in the design process. It is, therefore, an important prerequisite and an essential companion for the CSEC Industrial Technology programmes which provide the foundational competencies in manufacturing and industrialisation in the Caribbean.

The syllabus focuses on the development of competencies in geometric construction, descriptive geometry, engineering designs and graphics, electrical, mechanical, manufacturing and construction drafting. These are geared toward the development of students' spatial visualisation, technical communication, interdisciplinary and employability skills. These skills are useful for careers in education, drafting, architecture, surveying, engineering (robotics, fabrication and civil), interior, spacial and structural, engineering designing, and in the general construction and manufacturing industries. In addition, the programme of studies in the syllabus caters for those students who will seek entry level employment in related fields.

The formulation of the syllabus takes into consideration the development of selected attributes of the Ideal Caribbean Person as documented in the 2000 Caribbean Education Strategy. This person is one who is emotionally secure with a high level of self-confidence and self-esteem; is aware of the importance of living in harmony with the environment; demonstrates multiple literacies, independence and critical thinking; values and displays the creative imagination in its various manifestations and nurtures its development in the economic and entrepreneurial spheres in all other areas of life.

The Technical Drawing syllabus integrates the principles of Competency Based Education, Training and Assessment (CBETA) in the School-Based Assessment component. This strategy is consistent with the seamless articulation among CXC's qualifications to facilitate an appropriate balance between the academic and technical subjects and to improve work-based performance. These competencies align with the UNESCO Pillars of Learning – learning to know, learning to do, learning to live together, learning to be and learning to transform one's self and society.

◆ AIMS

The syllabus aims to:

1. enable students to acquire an understanding of the relationship of design and drawing in manufacturing and industrialisation;
2. provide students with the competencies required for understanding, interpreting and producing technical drawings aligned with established standards, conventions and technology;
3. develop students' critical thinking, quality standards and teamwork skills in the production of drawings using traditional methods or design software packages;
4. develop students' appreciation of creativity, imagination and aesthetics in designs and drawings;
5. provide students with foundation competencies in entrepreneurial skills for employment creation and economic development.

◆ ORGANISATION OF THE SYLLABUS

The syllabus is divided into four (4) Sections:

SECTION 1 - Fundamentals of Technical Drawing

- (a) Occupational Health, Safety and the Environment.
- (b) Equipment, Tools, Materials, Lettering, Line Work, Dimensions and Scales.

SECTION 2 - Geometrical Construction

- (a) Plane Geometry.
- (b) Solid Geometry.

SECTION 3 - Building Drawing

SECTION 4 - Mechanical Engineering Drawing

Candidates are expected to undertake SECTION 1: Fundamentals of Technical Drawing, SECTION 2: Geometrical Construction and **EITHER** SECTION 3: Building Drawing **OR** SECTION 4: Mechanical Engineering Drawing.

◆ RECOMMENDED TEACHING APPROACH

In developing the plan to deliver and assess the syllabus, the teacher is asked to carefully note the areas of the syllabus that overlap with the Units of Competence in the Regional Occupational

Standards. These Units of Competence are tied to the SBA component and should be delivered and assessed concurrently.

The teacher is encouraged to combine institutional and industry training (dual) to facilitate students learning. Students are to be exposed to a wide range of activities that will allow them to have authentic learning experiences. This may be facilitated through projects, field studies, industry attachment, partnerships with National Training Agencies and the use of simulators and/or other virtual activities.

◆ SUGGESTED TIMETABLE ALLOCATION

It is recommended that a minimum of six 40-minute periods per week, over two academic years or the equivalent be allocated to the syllabus. Single periods are not recommended.

ALLIED SUBJECTS

Candidates should be encouraged to include the following subjects in their programme of study: One of the Industrial Technology subjects (Building Technology; Mechanical Engineering Technology; Electrical and Electronic Technology), English A, Mathematics, Physics.

◆ CERTIFICATION

The Technical Drawing course is an integral component of the Technical and Vocational Education and Training (TVET) programme offered by the Council. *It will be examined for certification at Technical Proficiency. A candidate's performance will be indicated on the certificate by an overall numerical grade on a six-point scale as well as a letter grade for each of three profile dimensions, namely, Knowledge, Application and Practical Ability. Candidates have the option of using either the Traditional Drawing Method (drawing board and tee square) or Computer-Aided Drafting (CAD) method/applications.*

The School-Based Assessment component for this syllabus is aligned to selected Units of Competence within the regional qualification of the Caribbean Vocational Qualification (CVQ). Through this integration every student with acceptable grades, where applicable may exit with recognition of competencies for the drawing unit from the Level 1 Caribbean Vocational Qualification (CVQ) in:

1. *General Construction (CCBCG10102), Draw and interpret simple drawings (BCGCOR0031A);*
2. *Furniture Making (CCLMF10103), Read and interpret work documents (LMFCOR0071A);*
3. *Electrical Installation (CCMEM11002), Draw and interpret sketches and simple drawings (MEMCOR0091A); or,*
4. *Metal Work Engineering (CCMEM10302), Draw and interpret sketches and simple drawings (MEMCOR0091A).*

The decisions to award competencies will be based on the quality and relevance of the evidences presented to the occupational area.

◆ DEFINITION OF PROFILE DIMENSION

On completion of the syllabus, in addition to the overall grade, candidate performance will be reported under the following profile dimensions:

1. Knowledge;
2. Application;
3. Practical Ability.

Knowledge

The ability to:

recall and comprehend terms, principles, methods, theories and structures.

Application

The ability to:

1. use concepts, principles, methods and theories to solve problems in a given situation;
2. analyse, synthesise and evaluate; interpret and extrapolate.

Practical Ability

The ability to:

demonstrate manipulative skills involving the use of Computer-Aided Drafting methods, drawing instruments, equipment and materials in problem solving situations.

◆ FORMAT OF THE EXAMINATION

EXTERNAL ASSESSMENT

Paper 01
(1 ¼ hours)

This paper will consist of 60 multiple-choice items, focusing on Section 1 (Fundamentals of Technical Drawing) and Section 2 (Geometrical Construction – Plane & Solid Geometry).

On this paper, Knowledge, Application and Practical Ability will be tested. Each item will be worth one mark.

This paper will represent 60 marks (20 per cent) of the total score.

Paper 02
(2 hours)

This paper will consist of two compulsory structured questions. There are **two separate papers**, one for Mechanical Engineering Drawing and one for Building Drawing.

Question 1 will be worth 90 marks of which 18 will be for Knowledge, 36 for Application and 36 for Practical Ability.

Question 2 will be worth 30 marks of which 6 will be for Knowledge, 11 for Application, and 13 for Practical Ability.

This paper will contribute 120 marks (40 per cent) to the total score.

The CSEC External Assessment will contribute 180 marks (60 per cent) to the total score.

Paper 03

The SBA assessment will contain:

- One piece from Section 1 (Specific Objectives 1 to 10) and Section 2 (Specific Objectives 1 and 2). This is a written question.
- Two pieces from Section 2 (Plane Geometry and Solid Geometry).
- The projects from Section 3 or Section 4.

WEIGHTING OF PAPERS AND PROFILES

The table below shows the marks assigned to each component of the assessment, and to each profile and the percentage contribution of each paper to the total score.

Table 1 – Percentage of Weighting of Papers and Profiles

PAPERS	KNOWLEDGE	APPLICATION	PRACTICAL ABILITY	TOTAL RAW	Weighting
EXTERNAL ASSESSMENT					
Paper 01 Multiple Choice questions	30	24	6	60	20%
Paper 02 Structured Questions	24	47	49	120	40%
Question 1	18	36	36	90	
Question 2	6	11	13	30	
SCHOOL-BASED ASSESSMENT					
Paper 03 SBA Portfolio of Evidence	15	34	71	120	40%
	69	105	126	300	100%

COMPOSITION OF PAPERS BY SECTIONS

The table below shows the composition of the papers by sections.

Table 2 – Composition of Papers by Sections

ASSESSMENT	Section 1 Fundamentals of Drawing	Section 2 Geometrical Construction	Section 3 Building Drawing	Section 4 Mechanical Engineering Drawing
EXTERNAL ASSESSMENT Paper 01 Multiple Choice questions	✓	✓		
Paper 02 Structured Questions	✓	✓	✓	✓
SCHOOL- BASED ASSESSMENT Paper 03 SBA Portfolio of Evidence	✓	✓	✓	✓

◆ REGULATIONS FOR PRIVATE CANDIDATES

Candidates who do not attend school full-time may undertake the course as a private candidate. A private candidate is one not entered through a school or other approved educational institution.

Such a candidate must observe the following guidelines:

1. complete *all the components of the examination*;
2. identify a teacher/tutor from a registered institution (school/technical institute/community college) who will assess and approve the candidate's submission for the School-Based Assessment component of the syllabus; and,
3. submit the name, school, and territory of the identified teacher/tutor to the Council on registration for the subject.

◆ REGULATIONS FOR RESIT CANDIDATES

Resit candidates must rewrite Papers 01 and 02 of the examination for the year in which they re-register. However, resit candidates who have earned a moderated score 50 per cent or more of the maximum score for the School-Based Assessment component may elect not to repeat this component, provided they rewrite the examination no later than 2 years immediately following their first attempt.

Resit candidates who have obtained a moderated score of less than 50 per cent of the maximum score for the School-Based Assessment component must repeat the component at any subsequent sittings. Resit candidates may enter through schools, recognised educational institutions or the Local Registrar's Office.

◆ RECOMMENDED MINIMUM EQUIPMENT AND MATERIAL FOR TECHNICAL DRAWING SYLLABUS

TRADITIONAL DRAWING METHOD (For a Class of 20)

Any suitable classroom can be converted into a Drawing Room with the addition of Drawing Boards.

	EQUIPMENT	QUANTITY
1.	Drawing boards	20
	OR	
	Dual drawing desks	10
	OR	
	Drawing tables	20
2.	Half imperial tee-squares	20
3.	Pair of set squares	20
4.	Protractors, scales and French curves	20
5.	Templates	20
6.	Set of drawing instruments	20

In addition, students will be required to have the following:

7. a hand towel or cheese cloth;
8. a good eraser;
9. pencil – grades HB, F, H 2H.

COMPUTER-AIDED DRAFTING METHOD (For a Class of 10)

It is the responsibility of schools that select the Computer-Aided Drafting option to ensure that the required hardware and software are in place to achieve the objectives of the syllabus.

<u>Recommended Hardware</u>	<u>Quantity</u>
1. PC fitted with an Intel 80486 or Pentium CPU with the following features: (a) a 17 inch monitor; (b) mouse; and (c) keyboard	10
2. Laser Printer/Plotter	1
3. UPS/other power protection devices	1

Recommended Software

Computer-Aided Drafting software package offering the advanced features required to complete the syllabus objectives.

NB: *The School Edition of the software package selected should be purchased to facilitate its (legal) use on multiple computers.*

NOTES TO TEACHERS/FACILITATORS – COMPUTER-AIDED DRAFTING (CAD)

1. *Students should be encouraged to undertake a basic computer literacy course.*
2. *The Computer-Aided Drafting (CAD) application mentioned in this section should be covered by teachers/facilitators and students to achieve the objectives of this syllabus. Those that are mentioned are not exhaustive in covering all the required operations and functions available within a CAD programme.*

The sequence mentioned is just a suggestion to teachers/facilitators. Teachers are, however, encouraged to develop their own sequential order.

3. **SUGGESTED OPERATIONS**

- (a) *Launch CAD programme.*
- (b) *Set unit and limits.*
- (c) *Set layers.*
- (d) *Locate and use tool bars, i.e. dimensions, draw, layers, modify, text, zoom, viewport, standard, properties.*
- (e) *Status bar, such as snap, polar, ortho, grid, OSNAP, otracking, lineweight, model and paper space.*
- (f) *Use of command lines, keyboards.*
- (g) *Dimensioning.*
- (h) *Viewports, scales and scale factors.*
- (i) *Save file.*
- (j) *Print/plot.*

◆ SECTION 1: FUNDAMENTALS OF TECHNICAL DRAWING

1A: OCCUPATIONAL HEALTH, SAFETY AND THE ENVIRONMENT

GENERAL OBJECTIVES

On completion of this Section, students should:

1. demonstrate a working knowledge of safety and maintenance standards governing workshop/laboratory and the use of drawing equipment and materials; and,
2. develop an awareness of safety and occupational health hazards and their preventative procedures and practices.

SPECIFIC OBJECTIVES

Students should be able to:

1. discuss safety, health and welfare standards for the technical drawing workshop/laboratory;
2. develop safety, health and welfare requirements governing workshop/laboratory;
3. classify safety resources for specific operations;
4. classify the different types of fires and fire-fighting equipment;
5. use a fire extinguisher;
6. differentiate among accident, injury and emergency;
7. apply basic First Aid principles and practices;
8. explain how to get professional help when an accident occurs;
9. identify hazards and hazardous substances; and,
10. perform mock drills for emergencies.

CONTENT

1. Safety, health and welfare standards

- (a) Standards for:
 - (i) workshop/laboratory;
 - (ii) equipment; and,
 - (iii) materials.

1A: OCCUPATIONAL HEALTH, SAFETY AND THE ENVIRONMENT (cont'd)

(b) *Occupational Health and Safety (OHS).*

(c) *Guidelines for:*

(i) *working safely;*

(ii) *enhancing wellness; and,*

(iii) *preventing injury and accident.*

2. Safety, health and welfare requirements

(a) *Inventory of materials, tools and equipment.*

(b) *Workshop/laboratory and equipment maintenance plans.*

(c) *Workshop/laboratory layout and shop organisation diagrams.*

(d) *List of danger points.*

(e) *Safety signs and symbols.*

(f) *Safety lanes.*

(g) *Personal Protective Equipment (PPE).*

(h) *Equipment guards.*

3. Safety resources

(a) *PPE:*

(i) *for different tasks; and,*

(ii) *preparing labelled diagrams of safety gear and accessories.*

4. Fires and fire-fighting equipment

(a) *Types of fires:*

(i) *Class A;*

(ii) *Class B;*

(iii) *Class C; and,*

(iv) *Class D.*

1A: OCCUPATIONAL HEALTH, SAFETY AND THE ENVIRONMENT (cont'd)

(b) *Fire-fighting equipment:*

- (i) *fire extinguishers (Class A, Class B, Class C and Class D);*
- (ii) *colour codes for fire extinguishers;*
- (iii) *fire hydrants; and,*
- (iv) *fire hoses.*

5. Using a fire extinguisher

- (a) *Safety guidelines and procedures for the various ranges of fires.*
- (b) *Preparing and maintaining report of usage.*
- (c) *Storage and maintenance of fire extinguishers.*

6. Accident, injury and emergency

- (a) *Differences.*
- (b) *Examples (falls, electric shock, minor damages to the eyes, broken bones, cuts).*

7. First Aid

- (a) *First Aid kit station.*
- (b) *Responsibilities of a First Aider.*
- (c) *Treating:*
 - (i) *burns;*
 - (ii) *electric burns;*
 - (iii) *cuts and abrasions;*
 - (iv) *heavy bleeding; and,*
 - (v) *practising mouth-to-mouth resuscitation and recovery position.*

1A: OCCUPATIONAL HEALTH, SAFETY AND THE ENVIRONMENT (cont'd)

8. Getting professional help

- (a) *Procedures for reporting an accident.*
- (b) *Emergency contacts:*
 - (i) *police;*
 - (ii) *fire services;*
 - (iii) *hospital and ambulance service;*
 - (iv) *Red Cross; and,*
 - (v) *the defence force.*
- (c) *Preparing an accident report.*

9. Hazards and hazardous substances

- (a) *Definitions:*
 - (i) *hazard; and,*
 - (ii) *hazardous substance.*
- (b) *Materials Safety Data Sheet.*
- (c) *Storing materials and supplies safely.*

10. Mock Drills

- (a) *Emergency procedures for a fire, an earthquake and a volcano.*
- (b) *Preparing mock drill reports.*

◆ SECTION 1: FUNDAMENTALS OF TECHNICAL DRAWING

1B: EQUIPMENT, TOOLS, MATERIALS, LETTERING, LINE WORK, DIMENSIONS AND SCALES

GENERAL OBJECTIVE

On completion of this Section students should understand the importance of Technical Drawing and its success in the appropriate choice and application of equipment, materials and processes in the production of drawings compliant with international standards.

SPECIFIC OBJECTIVES

Students should be able to:

- 1. discuss the importance of Technical Drawing to industry;*
- 2. discuss standards relating to technical drawings;*
- 3. outline the functions of equipment and materials used in technical drawing;*
- 4. demonstrate the use of tools and equipment;*
- 5. classify the various types of lines used in Technical Drawing;*
- 6. construct the various types of lines;*
- 7. apply basic lettering and dimensioning techniques;*
- 8. read and convert measures using various scales;*
- 9. apply the principles of freehand sketches;*
- 10. apply the principles of CAD;*
- 11. explain the steps in the design process;*
- 12. outline the principles and elements of design;*
- 13. discuss drawing skills in the design process; and,*
- 14. design building and engineering components given design specifications.*

1B: EQUIPMENT, TOOLS, MATERIALS, LETTERING, LINE WORK, DIMENSIONS AND SCALES (cont'd)

CONTENT

1. Importance of Technical Drawing as a universal language

- (a) to the manufacturing industries;
- (b) to engineering;
- (c) to architecture; and,
- (d) to designers.

2. International standards

- (a) AISI, ISO, BS standards.
- (b) Building codes and standards.
- (c) Engineering codes.

3. Functions of drawing equipment and materials

- (a) Equipment and tools:
 - (i) drawing boards;
 - (ii) T-squares;
 - (iii) drafting machines;
 - (iv) computers, plotters and printers;
 - (v) cameras;
 - (vi) scanners; and,
 - (vii) multimedia devices.
- (b) Drawing instruments:
 - (i) compasses;
 - (ii) triangles;
 - (iii) protractors;

1B: EQUIPMENT, TOOLS, MATERIALS, LETTERING, LINE WORK, DIMENSIONS AND SCALES (cont'd)

- (iv) *dividers;*
- (v) *French curves;*
- (vi) *templates;*
- (vii) *lettering guides;*
- (viii) *rulers; and,*
- (ix) *scales.*

(b) *Drawing materials:*

- (i) *drafting paper;*
- (ii) *tracing paper;*
- (iii) *erasers;*
- (iv) *dusting cloth; and,*
- (v) *ink.*

4. Using tools and equipment

Techniques and guidelines for different tasks:

- (a) aligning paper to drawing desk;
- (b) constructing title block;
- (c) lettering (styles, upper and lower case);
- (d) lines and line quality;
- (e) dimensioning principles; and,
- (f) producing simple sketches (manual and basic computer operations).

**1B: EQUIPMENT, TOOLS, MATERIALS, LETTERING, LINE WORK, DIMENSIONS AND SCALES
(cont'd)**

5. Types of lines

- (a) The alphabet of lines.
- (b) Line styles *and conventions*.
- (c) *Function/s of each line*.
- (d) *Pencil selection and line quality*.
- (e) *Drawing toolbars*.

6. Line construction

Guidelines and techniques for:

- (a) *constructing the alphabet of lines using free-hand, instruments (T-squares and triangles) and computer software;*
- (b) *line weight/thickness*.

7. Lettering and dimensioning techniques

- (a) *Principles, guidelines and techniques for lettering:*
 - (i) styles;
 - (ii) guidelines;
 - (iii) *uniformity and spacing*;
 - (iv) size;
 - (v) *pencil size and techniques*;
 - (vi) *calligraphy*;
 - (vii) *fonts/texts; and,*
 - (viii) *annotation*.

1B: EQUIPMENT, TOOLS, MATERIALS, LETTERING, LINE WORK, DIMENSIONS AND SCALES (cont'd)

- (b) *Principles, guidelines and techniques for dimensioning:*
 - (i) unidirectional and aligned style of dimensions;
 - (ii) dimension lines, *extension lines, leaders, arrow heads*;
 - (iii) *circles, arcs, radius, diameter*;
 - (iv) *tolerances, limits and fits*;
 - (v) *numbers (standard, metric and decimal); and,*
 - (vi) *dimension toolbar (CAD).*

8. Scales

- (a) *Reading and interpreting:*
 - (i) *draftsmen*;
 - (ii) *engineers*;
 - (iii) *architects; and,*
 - (iv) *standard and metric.*
- (b) *Measuring with scales.*
- (c) *Converting units of measurement.*
- (d) *Applying ratios in engineering and construction drawings according to codes and regulations.*

9. Free-hand sketching

- (a) *Using grid and plane papers.*
- (b) *Pictorial and orthographic drawings.*
- (c) *Sketching in proportion.*
- (d) *Graphic symbols.*
- (e) *Line work.*
- (f) *Sketching of building and engineering components*

1B: EQUIPMENT, TOOLS, MATERIALS, LETTERING, LINE WORK, DIMENSIONS AND SCALES (cont'd)

10. Using CAD principles:

Refer to page 8 for further details.

11. The design process

- (a) Identification of the problem.*
- (b) Design of initial ideas to solve the problem.*
- (c) Proposed solution.*
- (d) Development and testing of models/prototypes.*
- (e) Development of working drawings, notes and sketching to explain each step in the process.*

12. Principles and Elements of design

- (a) Elements of design:*
 - (i) line;*
 - (ii) space;*
 - (iii) form;*
 - (iv) proportion;*
 - (v) harmony;*
 - (vi) dominance; and,*
 - (vii) finishes.*
- (b) Principles of design:*
 - (i) aesthetics;*
 - (ii) ergonomics;*
 - (iii) economics;*
 - (iv) material; and,*
 - (v) construction.*

**1B: EQUIPMENT, TOOLS, MATERIALS, LETTERING, LINE WORK, DIMENSIONS AND SCALES
(cont'd)**

13. Drawings Skills in the design process

- (a) Working drawings.
- (b) Principles of Projection.
- (c) Manual and computer-aided drafting/design.

14. Designing building and engineering components

- (a) Implementing the design process using simple building and engineering components.
- (b) Codes and regulations.
- (c) Scales.
- (d) Materials.
- (e) Design presentation and evaluation.

◆ SECTION 2: GEOMETRICAL CONSTRUCTION

2A: PLANE GEOMETRY

GENERAL OBJECTIVES

On completion of this Section, students should:

1. understand the principles of plane geometry and their application in the production of geometric figures and shapes;
2. appreciate the principles of plane geometry in the analysis and solution of drawing and design problems in architecture, construction and engineering; and,
3. demonstrate proficiency in the use of plane geometry tools, materials and equipment.

SPECIFIC OBJECTIVES

Students should be able to:

1. differentiate between “plane geometry” and “solid geometry”;
2. apply plane geometrical construction principles using manual and computer-aided methods;
3. construct tangents to given specifications;
4. apply the basic principles of analytic geometry to Loci;
5. illustrate the path of points in simple mechanisms;
6. contrast between mathematical and graphical representations of areas of figures;
7. construct plane geometric figures equal in areas to other figures;
8. divide triangles and polygons into a number of equal and proportional parts; and,
9. reduce and enlarge plane figures by linear measurements, ratio of sides and ratio of areas.

CONTENT

1. Solid and plane geometry

(a) Definitions:

- (i) solid geometry; and,
- (ii) plane geometry.

SECTION 2A: PLANE GEOMETRY (cont'd)

(c) Differences:

- (i) functions and features of plane and solid geometry; and,
- (ii) geometric terms and concepts.

2. Plane Geometry

(a) Lines:

- (i) drawing perpendicular to a given line, at a point on the line and from a point outside the line;
- (ii) drawing a line parallel to a given line;
- (iii) bisecting a given line; *and*,
- (iv) dividing straight lines geometrically (parts of equal lengths and the use of proportion and ratio).

(b) Angles:

- (i) definition;
- (ii) types;
- (iii) properties;
- (iv) copying or transferring any given angle;
- (v) bisecting given angles;
- (vi) bisecting angles formed by two lines;
- (vii) constructing angles (90, 75, 60, 45, 30, 15 degrees and others);
- (viii) replicating geometrical shapes using angle vertices, and converging lines as points of reference;
- (ix) dimensioning and lettering techniques; *and*,
- (x) line characteristics.

(c) Triangles:

- (i) definitions;
- (ii) types;
- (iii) properties; *and*,

SECTION 2A: PLANE GEOMETRY (cont'd)

- (iv) constructing a triangle (given three sides; two angles and one side; two sides and included angle; perimeter and proportion of sides; altitude and base angles; perimeter and base angles).
- (d) Quadrilaterals:
 - (i) definitions;
 - (ii) types;
 - (iii) properties;
 - (iv) constructing a square (given the length of one side, the perimeter, the diagonal);
 - (v) constructing a rectangle (given the length of the diagonal and one side, perimeter and the length of one side);
 - (vi) constructing a parallelogram (given the lengths of two adjacent sides and an angle, perpendicular height, one side and one internal angle);
 - (vii) constructing a rhombus (given the length of the sides; one diagonal and the length of one side); *and*,
 - (viii) constructing a trapezium (given the lengths of the sides, perpendicular distance between them and one angle).
- (e) Polygons:
 - (i) definitions (regular and irregular polygons);
 - (ii) types;
 - (iii) properties;
 - (iv) constructing any regular polygon (given the length of a side; diagonal or within a given circle); *and*,
 - (v) constructing any irregular polygon (given the length of the sides, the included angles).

3. Tangents

- (a) Definition.
- (b) Properties.

SECTION 2A: PLANE GEOMETRY (cont'd)

- (c) Tangency of circles, arcs and straight lines.
- (d) Internal and external tangents, centres and tangency points.
- (e) Drawing arcs tangential to two straight lines at acute, right and obtuse angles.
- (f) Constructing the common internal and external tangents to two given circles.
- (g) Drawing an arc tangential to two given circles of different radii.
- (h) Drawing lines, arcs and circles to blend tangentially to create geometric shapes.

4. **Analytic geometry**

- (a) Definition, properties and characteristics of ellipse, parabola and hyperbola.
- (b) Constructing an ellipse using the foci (major and minor axis), rectangular and concentric circle methods.
- (c) Constructing a parabola using the locus (distance of the vertex from the directrix) and rectangular methods (span and height).
- (d) Constructing a hyperbola with a given ratio 3:2 (transverse axis and the F focus).
- (e) Constructing an ellipse using trammel method.
- (f) Constructing the tangents and normal to the curves.
- (g) Constructing an Archimedean spiral given the pole and the longest and shortest radii.
- (h) Constructing an involute given the diameter of the circle, triangle, square and regular polygon.

5. **Path of points in simple mechanism**

Collaboration with industry, firms and the industrial technology programmes to access the use of simple mechanisms or representatives of:

- (a) *sliding ladders;*
- (b) *rotating cranks;*
- (c) *screw threads;*

SECTION 2A: PLANE GEOMETRY (cont'd)

- (d) cones;
- (e) helical and square springs; and,
- (f) the cycloid.

6. **Mathematical and graphical representation of areas of figures**

Differences in shapes and functions of mathematical and graphical representation of:

- (a) rectangles;
- (b) squares;
- (c) triangles;
- (d) circles; and,
- (e) regular and irregular polygons.

7. **Geometric figures equal in areas to other figures**

- (a) Constructing a rectangle of equivalent area to:
 - (i) acute and right (angled) triangles; and,
 - (ii) obtuse triangles.
- (b) Constructing a square of equivalent area to:
 - (i) a regular polygon; and,
 - (ii) an irregular polygon.

8. **Division of triangles and polygons**

- (a) Construction principles of similar and proportional triangles.
- (b) Dividing triangles and polygons in a number of equal and proportional parts.

SECTION 2A: PLANE GEOMETRY (cont'd)

9. Reducing and enlarging plane figures

- (a) Principles of reducing and enlarging areas of plane figures.
- (b) Reducing and enlarging plane figures by:
 - (i) linear measurements;
 - (ii) ratio of sides; and,
 - (iii) ratio of areas.

◆ SECTION 2: GEOMETRICAL CONSTRUCTION

2B: SOLID GEOMETRY

GENERAL OBJECTIVES

On completion of this Section, students should:

1. *understand the principles of projecting lines, planes, and views in solid geometry;*
2. *develop proficiency in the use of equipment, tools and materials using the principles and practices in traditional and conventional drawing methods; and,*
3. *apply the principles of sketching, pictorial and orthographic projections.*

SPECIFIC OBJECTIVES

Students should be able to:

1. *compare the various types of pictorial drawings;*
2. *prepare pictorial drawings;*
3. *discuss the principles of First and Third angle projections;*
4. *prepare orthographic drawings of geometrical solids;*
5. *examine the importance of sectional drawings;*
6. *prepare sectional views of geometrical solids;*
7. *determine the true shapes of sectioned surfaces of geometric solids;*
8. *discuss the different types of auxiliary views;*
9. *prepare auxiliary drawings;*
10. *explain the importance of surface development;*
11. *construct surface development of oblique and frustum solids;*
12. *construct curves of interpenetration of geometric solids with their axes in the same plane;*
13. *draw helical spring of circular cross-section;*
14. *draw orthographic views given pictorial drawings;*
15. *prepare pictorial drawings given orthographic views; and,*
16. *solve drawing problems using orthographic and pictorial projections.*

SECTION 2B: SOLID GEOMETRY (cont'd)

CONTENT

1. Pictorial drawings

- (a) Types of pictorial drawings:
 - (i) isometric;
 - (ii) oblique; *and*,
 - (iii) perspective.
- (b) *Characteristics and uses of each type.*
- (c) *Advantages and disadvantages of each type.*
- (d) *Principles of projection for points, lines and planes from one view to the other.*

2. Producing pictorial drawings

- (a) Isometric drawings:
 - (i) *regular shaped objects;*
 - (ii) *irregular shaped objects;*
 - (iii) *objects with inclined surfaces;*
 - (iv) *given the plan and front elevation;*
 - (v) *drawings with isometric circles;*
 - (vi) *drawings with isometric curves; and,*
 - (vii) *exploded isometric drawings.*
- (b) Oblique drawings:
 - (i) *drawing geometric solids in cavalier and cabinet projections; and,*
 - (ii) *drawing figures with curves and circles in cabinet and cavalier oblique projections.*

SECTION 2B: SOLID GEOMETRY (cont'd)

- (c) Perspective drawings:
 - (i) drawing geometric solids in 1-point perspective; *and*,
 - (ii) drawing geometric solids in 2-point perspective.

3. First and third angle projections

Principles relating to the planes of projection:

- (a) horizontal planes;
- (b) vertical planes;
- (c) plans; *and*,
- (d) elevations.

4. Orthographic drawings of geometrical solids

- (a) Simple models.
- (b) Truncated solids:
 - (i) rectangular prism and pyramid; *and*,
 - (ii) hexagonal prism.

5. Sectional drawings

- (a) *Types.*
- (b) *Characteristics.*
- (c) *Uses.*
- (d) *Preparing sectional drawings:*
 - (i) *full sections;*
 - (ii) *half sections;*
 - (iii) *offset sections;*

SECTION 2B: SOLID GEOMETRY (cont'd)

- (iv) *revolved sections;*
- (v) *removed sections; and,*
- (vi) *broken out sections.*

6. Sectioned surfaces of geometric solids

- (a) Right cones.
- (b) Cylinders.
- (c) Prisms.
- (d) Pyramids.

7. Determining true lengths of straight lines

Methods:

- (a) *revolution; and,*
- (b) *auxiliary methods.*

8. Auxiliary views

- (a) *Types:*
 - (i) *primary auxiliary views; and,*
 - (ii) *auxiliary views that include curved lines.*
- (b) *Uses and characteristics of the different types.*

9. Preparing auxiliary drawings

- (a) Planes of projection for both *inclined and sloping surfaces.*
- (b) Oblique planes inclined to horizontal and vertical planes.

SECTION 2B: SOLID GEOMETRY (cont'd)

10. Surface development

Uses of surface development for oblique solids and frustum of solids (relevant to the sheet metal industry).

11. Constructing surface developments of oblique and frustum solids

- (a) Applying parallel line and radial development methods for constructing:
 - (i) prisms;
 - (ii) cylinders;
 - (iii) cones;
 - (iv) pyramids;
 - (v) truncated hexagonal pyramid, truncated cylinder;
 - (vi) intersecting cylinders joined at angles; and,
 - (vii) cylinders joined at 90 and 60 degree angles (large and small cylinders).
- (b) Determining true lengths and shapes of the surfaces.

12. Curves of interpenetration

- (a) Importance of lines of intersection and their importance in joining solids.
- (b) Constructing curve of interpretation of geometric solids with their axes in the same plane, *horizontal sections, and angles of axes of joined solids.*
- (c) Finding the intersecting lines of two prisms.
- (d) Drawing the curve of interpenetration of two cylinders.

13. Helical spring

- (a) Circular cross-section of:
 - (i) helix curves;
 - (ii) pitch;

SECTION 2B: SOLID GEOMETRY (cont'd)

- (iii) lead; and,
 - (iv) helical and square spring helix.
- (b) Constructing a single helical curve on a cylinder.

14. Drawing orthographic views

- (a) Horizontal and vertical planes of projection.
- (b) Plans and Elevations.

15. Preparing pictorial drawings

- (a) Isometric.
- (b) Oblique.
- (c) Perspective.

16. Solving drawing problems

- (a) Using pictorial drawings:
 - (i) isometric;
 - (ii) oblique; and,
 - (iii) perspective.
- (b) Using First and Third Angle orthographic projections.

◆ SECTION 3: BUILDING DRAWING

GENERAL OBJECTIVES

On completion of the Section, students should:

1. *understand building standards in the interpretation and preparation of building drawings;*
2. *develop proficiency in the selection and application of appropriate scales for various building drawings;*
3. *develop a working knowledge of the principles of sketching and working drawings;*
4. *appreciate the importance of drafting principles in the analysis and solution of building design problems; and,*
5. *understand the basic principles of entrepreneurship in architectural services and products.*

SPECIFIC OBJECTIVES

Students should be able to:

1. discuss the uses of building standards in the preparation and interpretation of building drawings;
2. discuss the types of drawings used in the building industry;
3. differentiate among various types of architectural drawings;
4. evaluate standard architectural practices;
5. prepare architectural drawings to specifications;
6. compare entrepreneurship and wage employment;
7. discuss the principles of entrepreneurship; *and,*
8. prepare a small business plan for a viable service or product in architecture.

CONTENT

1. **Standards**
 - (a) BSI.
 - (b) ISO.

SECTION 3: BUILDING DRAWING (cont'd)

- (c) CUBiC.
- (d) Local standards.

2. *Types of drawings used in the building industry*

- (a) *Types:*
 - (i) *site plans;*
 - (ii) *location plans;*
 - (iii) *building plans; and,*
 - (iv) *elevations and sectional views.*
- (b) *Uses and characteristics of each type of plan.*
- (c) *Labelled sketches of each type of plan.*

3. *Types of architectural drawings*

- (a) *Types:*
 - (i) *site plans;*
 - (ii) *general location plans;*
 - (iii) *foundation plans;*
 - (iv) *floor plans;*
 - (v) *building plans; and,*
 - (vi) *elevations and sectional views.*
- (b) *Uses of each type of drawing.*
- (c) *Scales used in preparing the different types of drawings.*
- (d) *Conventional symbols and sketches.*

SECTION 3: BUILDING DRAWING (cont'd)

4. Standard architectural practices

- (a) *Line characteristics.*
- (b) Lettering and dimensioning.
- (c) Symbols.
- (d) Conventions.
- (e) Labelling.
- (f) Notes and annotations.

5. Architectural drawings

- (a) Preparing a drawing sheet:
 - (i) Selecting paper size.
 - (ii) Checking alignment.
 - (iii) Drawing border line.
 - (iv) Preparing title block.
 - (v) Line characteristics.
 - (vi) Lettering and dimensioning.
- (b) Producing 2D and 3D solid model drawings of a building or its component using CAD.
- (c) Drawing working plans of building sites:
 - (i) importance of site investigation.
 - (ii) common site clearance practices (demolishing, salvaging, cutting, burning, earth-moving and disposing).
 - (iii) preparing site plans.

SECTION 3: BUILDING DRAWING (cont'd)

- (iv) factors important to site layout:
 - slope;
 - layout of land;
 - drainage;
 - sewer disposal;
 - fencing;
 - locating boundaries;
 - building regulation for site layout;
 - components of site plan; and,
 - introduction to sub-soils.

- (d) *Drawing foundations:*
 - (i) *preparing* simple working drawings of foundation work.
 - (ii) *sketching* concrete foundations of buildings.
 - (iii) *preparing* orthographic, pictorial and freehand sketches of simple reinforcement of foundation work:
 - simple working drawings of foundation work (simple concrete foundations for level and sloping ground); and,
 - preparing drawings of common footings used in building construction (instruments drawings/section details).
 - (iv) drawing foundation plans (position of foundation wall and footing, *line type, line weight, layer, hatching, offset*).

- (e) *Drawing floors:*
 - (i) *preparing drawings* of various types of floor and floor section – *timber and concrete*.
 - (ii) *preparing drawings* of solid, hollow and suspended ground floor and floor coverings (tiles, screed, *hardwood, others*).

SECTION 3: BUILDING DRAWING (cont'd)

(f) *Drawing* floor plans and elevations:

(i) *sketching* of floor plans.

(ii) *Designing and laying out* simple floor plans from given specifications:

- orientation and relationship of rooms, positioning of walls, windows, floors, doors, stairs, arches, bathroom and kitchen symbols;
- line work, dimensioning, annotation;
- measuring to scale;
- drawing floor plans to given scales;
- drawing elevations of buildings;
- projections and orientation; and,
- ground line, floor line, doors and windows in elevation, height of roof, fascia, eave, rendering.

(g) *Drawing* internal and external walls and finishing:

(i) *types of walls*:

- stone rubble;
- concrete block;
- brick; and,
- composite walls.

(ii) differentiating between internal and external load bearing and non-load bearing walls (construction of walls in blocks and timber):

- *drawing* detailed framed timber partition (treatment of openings in walls);
- *preparing* working drawings of wall details; and,
- *internal and external rendering (sectional details) of load and non-load bearing walls*, treatment of openings in walls, lintels and ring beams/belt beams, plastering to walls and ceilings.

SECTION 3: BUILDING DRAWING (cont'd)

- (h) Drawing types of roofs in the Caribbean region:
- (i) preparing plans and elevations of various types of roofs and roof structures – flat roofs in timber and reinforced concrete and roof construction with various coverings – treatment of gutters, parapets and vent pipes;
 - (ii) preparing working drawings of roof anchorage systems (hurricane clips/straps, bolts);
 - (iii) preparing working drawings of roofs showing truss details (simple contemporary timber trusses); and,
 - (iv) preparing working drawings showing open and closed eaves:
 - eave details;
 - dimensioning and annotations.
- (i) *Drawing doors and windows:*
- (i) types of doors and windows;
 - (ii) preparing drawings of internal and external doors and windows with linings and frames;
 - (iii) preparing detailed section of a sliding window in a masonry wall (horizontal and vertical sliding windows);
 - (iv) preparing typical sectional drawings which show door and window details and fittings; and,
 - (v) positioning of hinges and locks, plastic hinges and locks.
- (j) *Preparing sectional drawings:*
- (i) *preparing* full sectional drawings of single-storey buildings;
 - (ii) *using* the principles of orthographic projection for:
 - foundations;
 - floors;
 - walls;
 - roofs; and,

SECTION 3: BUILDING DRAWING (cont'd)

- *preparing* details of different building components such as ridge, eaves, foundations, floors, footings and anchorage.

(k) *Drawing* elevations:

- (i) sketching elevations from given plans;
- (ii) sketching elevations of building plans;
- (iii) *drawing* stairs;
- (iv) principles of construction of stairs (straight flight stairs with landings – timber and reinforced concrete);
- (v) calculating *risers* from given height;
- (vi) *preparing* sectional working drawing of a straight flight staircase; and,
- (vii) *preparing* detailed drawing of the parts of a step.

6. **Comparing entrepreneurship and wage employment**

- (a) *Definitions.*
- (b) *Importance.*
- (c) *Characteristics of wage entrepreneurship.*
- (d) *Characteristics of wage employment.*

7. **Principles of entrepreneurship**

- (a) *Small business planning.*
- (b) *Goal setting.*
- (c) *Value creation.*
- (d) *Product marketing.*
- (e) *Sales and promotion.*

SECTION 3: BUILDING DRAWING (cont'd)

8. *Preparing a small business plan*

- (a) *Identification of the service or product;*
- (b) *Elements and format of a small business plan; and,*
- (c) *Group presentation and evaluation.*

◆ SECTION 4: MECHANICAL ENGINEERING DRAWING

GENERAL OBJECTIVES

On completion of the Section, students should:

- 1. develop proficiency in the concepts and conventions for the interpretation and creation of engineering drawings;*
- 2. understand the principles and techniques of sketching, working and assembly drawings in accordance with standards, specifications and instructional guidelines;*
- 3. observe safety and maintenance standards governing the use of drawing tools, equipment and materials according to specifications and instructional guidelines;*
- 4. demonstrate application of the principles and standards of engineering drawings to analyse and solve design problems; and,*
- 5. understand the basic principles of entrepreneurship in Mechanical Engineering Drawing.*

SPECIFIC OBJECTIVES

Students should be able to:

- 1. discuss engineering drawing standards;*
- 2. discuss basic engineering materials;*
- 3. identify conventional representations of standard engineering components;*
- 4. interpret symbols of machine parts and components;*
- 5. identify welding and brazing symbols of fabricated parts and components;*
- 6. prepare engineering drawings;*
- 7. compare entrepreneurship and wage employment;*
- 8. discuss the principles of entrepreneurship; and,*
- 9. prepare a small business plan for a viable service or product.*

SECTION 4: MECHANICAL ENGINEERING DRAWING (cont'd)

CONTENT

1. **Engineering drawing standards**

- (a) *International standards relating to:*
 - (i) *line styles and types;*
 - (ii) *lettering;*
 - (iii) *drawing sheets;*
 - (iv) *engineering components and features;*
 - (v) *abbreviations and terms;*
 - (vi) *symbols;*
 - (vii) *surface finishes;*
 - (viii) *tolerance; and,*
 - (ix) *limits and fits.*

2. **Engineering materials**

- (a) *Metals.*
- (b) *Non-metals.*
- (c) *Characteristics of each metal and non-metal material.*
- (d) *Advantages and disadvantages of metal and non-metal material.*

3. **Conventional representation of standard engineering components**

Features, terminologies, symbols and abbreviations of:

- (i) bearings;
- (ii) metric screw thread;
- (iii) shafts;
- (iv) springs;

SECTION 4: MECHANICAL ENGINEERING DRAWING (cont'd)

- (v) gears;
- (vi) knurl;
- (vii) flat and round;
- (viii) square;
- (ix) lap;
- (x) countersink;
- (xi) counterbore;
- (xii) spot face;
- (xiii) chamfer;
- (xiv) bevel;
- (xv) tubular sections;
- (xvi) *bush*;
- (xvii) *bearing*;
- (xviii) *housing*;
- (xix) *boss*;
- (xx) *rib*;
- (xxi) *curved slot*;
- (xxii) *fillet*;
- (xxiii) *key*;
- (xxiv) *keyway*;
- (xxv) *bolts*;
- (xxvi) *screws and studs*;
- (xxvii) *pins*;
- (xxviii) *springs*;

SECTION 4: MECHANICAL ENGINEERING DRAWING (cont'd)

(xxix) *worm and wheel;*

(xxx) *shaft ends; and,*

(xxxi) *splines.*

4. Symbols of machine parts

Symbols of components listed in **item 3**.

5. Welding and brazing symbols

Fabricated parts and components.

6. Engineering drawings

(a) *Sketching* engineering components:

(i) *sketching* engineering features using standard graphic symbols, sectional assemblies;

(ii) *sketching* temporary and permanent fasteners;

(iii) *producing* 3D solid model drawing of engineering components:

- shaped blocks;
- chisels;
- punches;
- nuts and bolts;
- hammers;
- saws;
- vee block;
- clamps;
- mallets;
- anvil;

SECTION 4: MECHANICAL ENGINEERING DRAWING (cont'd)

- welded joints;
- lathe tail stock;
- lathe centres;
- drill bits;
- taps and dies;
- reamers;
- spanners;
- wrenches;
- tri-square;
- snips;
- stakes;
- hand groover;
- rivet snap; and,
- tap wrench.

(b) *Preparing* title block:

- (i) title of drawing;
- (ii) scale;
- (iii) date of drawing;
- (iv) name of draftsman;
- (v) drawing number;
- (vi) revisions;
- (vii) symbol of projection;
- (viii) lettering;
- (ix) size of drawing sheets; and,
- (x) use of guidelines.

SECTION 4: MECHANICAL ENGINEERING DRAWING (cont'd)

- (c) Preparing orthographic drawings:
- (i) simple machine parts and components in first angle or third angle projection:
 - vee blocks;
 - plumber block;
 - tool holders;
 - tool post;
 - connecting rod;
 - pulley frame;
 - pulleys;
 - pulley yoke;
 - lever bracket;
 - machine vice body;
 - shaft bearing; and,
 - angle plate base, pivot block, bearing block and axle support.
 - (ii) *simple machine parts and components in scaled orthographic views (first angle or third angle projection).*
 - (iii) orthographic drawings of temporary and permanent engineering fasteners:
 - temporary fasteners - nuts and bolts, screws, studs, cotters, locknuts, slotted nuts, castle nuts, self-locking nuts, spring washers, saddle keys, round keys, feather keys, parallel keys, taper keys, woodruff keys, split pins; and,
 - permanent fasteners – rivets, conventional representation of welds and brazing: fillet, vee, butt, spot. Indication of direction, site and location of weld.
- (d) Dimensioning drawings:
- (i) stop (extension) lines;
 - (ii) dimension lines;

SECTION 4: MECHANICAL ENGINEERING DRAWING (cont'd)

- (iii) arrowheads;
 - (iv) leaders;
 - (v) overall dimensions;
 - (vi) chain dimensioning;
 - (vii) linear dimensioning;
 - (viii) dual dimensioning;
 - (ix) angular dimensioning;
 - (x) tolerance dimensions; and,
 - (xi) radius, diameter, circles, arcs and metric screw threads.
- (e) Sections
- (i) types of sections:
 - full;
 - half;
 - part;
 - off-set;
 - revolved;
 - removed; and,
 - local.
 - (ii) sectional plans and elevations of:
 - vee block;
 - plumber block;
 - connecting rod;
 - pulleys;
 - lever bracket;

SECTION 4: MECHANICAL ENGINEERING DRAWING (cont'd)

- machine vice body;
- shaft bearing;
- angle base plate;
- support block;
- support arm;
- support plate;
- brackets;
- jig body;
- shaper quadrant;
- tension block;
- bearing block;
- lathe tool post;
- link connector;
- compound rest; and,
- crank.

(f) *Preparing assembly drawings:*

(i) plans and elevations in first angle or third-angle projection of assembled machine parts and components:

- shaft and pulleys;
- castors;
- jigs and fixtures;
- machine and bench vices;
- bearing assemblies;
- universal couplings;

SECTION 4: MECHANICAL ENGINEERING DRAWING (cont'd)

- lathe steady;
 - pulley and hook;
 - shaft block and bearing;
 - tool supports and holders;
 - lathe tail stock;
 - valve link connector;
 - connecting rod and bearing;
 - screw jack;
 - scribing block;
 - clamping devices;
 - vee block and clamp;
 - crank and pin;
 - footstep bearing;
 - clapper box;
 - eccentrics;
 - tool rest;
 - pipe vice; and,
 - swivel.
- (ii) drawing sectional plans and elevations of assembled machine parts;
- (iii) reading and preparing working drawings of machine parts and components;
- (iv) preparing parts list of machine components; and,
- (v) parts list given machine components showing parts number, name of parts; number required, material, remarks; balloon referencing.

SECTION 4: MECHANICAL ENGINEERING DRAWING (cont'd)

7. **Entrepreneurship and wage employment**

- (a) *Definitions.*
- (b) *Importance.*
- (c) *Characteristics of wage entrepreneurship.*
- (d) *Characteristics of wage employment.*

8. **Principles of entrepreneurship**

- (a) *Small business planning.*
- (b) *Goal setting.*
- (c) *Value creation.*
- (d) *Product marketing.*
- (e) *Sales and promotion.*

9. **Preparing a small business plan**

- (a) *Identification of the service or product.*
- (b) *Elements and format of a small business plan.*
- (c) *Group presentation and evaluation.*

◆ SUGGESTED TEACHING AND LEARNING ACTIVITIES

To facilitate students' performance, teachers/facilitators are advised to engage students in the teaching and learning activities listed below.

- 1. Use PowerPoint presentations, simulations, videos, interactive boards, Internet, and CDs to support the teaching and expose students to industry standards, trends and practices. Students should be encouraged to journal lessons learnt from presentations.*
- 2. Organise work attachments (job placement, work experience, job shadowing or apprenticeship) with agencies of Government, drafting/architectural firms, fabrication/construction companies to give students an opportunity to observe the application of the various standards and compare the practices observed with the documented standards and expectations. Students can present their findings in class.*
- 3. Utilise subject specialists and practitioners from agencies of Government, drafting/architectural firms, fabrication/construction companies to make presentations and perform demonstrations for students.*
- 4. Arrange site visits to agencies of Government, drafting/architectural firms, fabrication/construction companies and suppliers of drawing equipment, tools and materials for students to observe standardised processes and interact with new drawing resources. Students can develop an instructional manual complete with safety precautions for the tools and equipment to which they were exposed on the visit.*
- 5. Monitor the completion and maintenance of the portfolio and ensure the pieces of evidence of the competencies that each student develops are included and validated against established standards and requirements and give students structured feedback.*

◆ GUIDELINES FOR THE SCHOOL-BASED ASSESSMENT

School-Based Assessment (SBA) is an integral part of candidates' assessment in the course covered by this programme. It is intended to facilitate the development of all the critical competencies (knowledge, skills, attitudes) emphasised by this programme. The SBA seeks to individualise a part of the programme to meet the needs of candidates, facilitate feedback to the candidates at various stages of the experience and help to build the self-confidence of candidates as they proceed with their studies. It enhances the validity of the examination on which candidate performance is reported, thereby, making a significant and unique contribution to the development of relevant academic and work-related skills.

The SBA is a composite of the marks derived from the portfolio pieces which show a clear integration of the recommended Units of Competence for the integration of the CVQ. The selected standards and Units of Competence for integration are:

1. *General Construction (CCBCG10102), Draw and interpret simple drawings (BCGCOR0031A);*
2. *Furniture Making (CCLMF10103), Read and interpret work documents (LMFCOR0071A);*
3. *Electrical Installation (CCMEM11002), Draw and interpret sketches and simple drawings (MEMCOR0091A); or*
4. *Metal Work Engineering (CCMEM10302), Draw and interpret sketches and simple drawings (MEMCOR0091A).*

*Two exemplars have been included in this syllabus. Teachers are encouraged to use these to guide the development of projects/practical activities for the School-Based Assessment component of this syllabus. Assessment is evidence-based. Candidates are therefore required to prepare and submit a portfolio of their work. **Please refer to Appendix III for Portfolio Development Guidelines.***

The CVQ is an award which represents the achievement of a set of competencies that define the essential (core) work practices of an occupational area consistent with the levels articulated within the Regional Qualifications Framework. It aims at the development of the Ideal Caribbean Worker, seeks to facilitate the movement of skilled certified workers within the CSME, and to enhance the quality profile and investment attractiveness of the work/labour force of CARICOM states while harmonising TVET systems across the region. The inclusion of the CVQ in secondary schools is a collaboration among the Ministry of Education, National Training Agencies/TVET Councils, Institutions and CXC.

The guidelines provided in this document for selecting appropriate tasks are intended to assist teachers/facilitators and candidates in formulating assignments that are valid for the purpose of SBA. The guidelines provided for the assessment of the assignments are intended to assist teachers/facilitators in awarding marks that are reliable indicators of the achievement of candidates in the SBA component of the programme.

SUGGESTED ACTIVITIES FOR THE SBA

The SBA assessment will contain:

1. One piece from Section 1 (Specific Objectives 1 to 10) and Section 2 (Specific Objectives 1 and 2). This is a written question.
2. Two pieces from Section 2 (Plane Geometry and Solid Geometry).
3. The projects from Section 3 or Section 4.

The following provides some suggested activities which could be used to enhance the learning experience provided by the SBA. This is by no means an exhaustive list as teachers/facilitators are encouraged to explore other creative activities intended to transform the learning environment.

- (a) *Oral questioning.*
- (b) *Oral presentation of design justification.*
- (c) *Presentation of design justification to teacher/facilitator or visiting Architect/Engineer in a formal atmosphere.*
- (d) *Internet exploration – evidence.*
- (e) *Freehand sketching.*
- (f) *Use of on-site situations when candidates could easily take measurements, soil tests.*
- (g) *Use of real machine parts.*
- (h) *Guest speakers from industry.*
- (i) *Peer assessment of designs.*
- (j) *Group assignments and marking.*
- (k) *Site visits.*

PROCEDURES FOR THE SCHOOL-BASED ASSESSMENT PORTFOLIO

As part of the School-Based Assessment, candidates will be required to produce a formative developmental portfolio providing evidence of candidates' progress and learning over the duration of the programme. This evidence may be in the form of sketches, design plans, quality control procedures, multi-view drawings, self-reflective statements, transcripts of interviews with industry professionals.

Since the portfolio is an accumulation of the candidates' ongoing learning across the course of the two-year programme, it must be started at the commencement of the Technical Drawing programme.

The pieces of evidence MUST depict the candidates' developmental progress in each section of the syllabus. It is advised that the topics of the content be integrated to give full coverage of each section of the syllabus. This integrated approach may result in the creation of evidence that covers more than one topic in the syllabus.

At a minimum, the portfolio must contain the following from each Section.

1. Section 1 (Fundamental of Technical Drawing):
 - (a) Evidence on Occupational Health Safety and the Environment;
 - (b) Checklist of evidence of site visit (for example, name of company, contact person, summary of organisation's health and safety practices, safety practice deficiencies identified, environmental practices, photographs or other forms of evidence);
 - (c) Project evidence on various types of lines, symbols, drawing conventions and codes;
 - (d) Project evidence on drawing equipment and instruments.
2. Section 2 (Geometrical Construction):
 - (a) Pieces of evidence on Plane Geometry and Solid Geometry;
 - (b) The evidence MUST be derived from different topics within the Section.
3. Section 3 or 4 (Building Drawing or Mechanical Engineering Drawing):
 - (a) Evidence of these sections will take the following format;
 - (b) Design/redesign a Building component or Mechanical Engineering device/gadget to solve a simple functional problem in one of the fourteen categories, namely:

Categories

- (i) agriculture/Fishing;
- (ii) business/office;
- (iii) communication;
- (iv) construction;
- (v) household;
- (vi) education facilities;
- (vii) environment;
- (viii) health facilities;
- (ix) manufacturing;

- (x) power;
- (xi) recreation;
- (xii) recycling;
- (xiii) sports; and,
- (xiv) transportation.

For **Building Drawing**, candidates will be required to produce the following:

- (a) sketch;
- (b) floor plan;
- (c) at least two elevations;
- (d) sectional view;
- (e) foundation plan or roof plan or sectional details of foundation and eaves; and,
- (f) a small business plan to encompass design justification and conditions.

For **Mechanical Engineering Drawing**, candidates will be required to produce the following drawings:

- (a) parts sheet;
- (b) orthographic projection of plan of the assembly;
- (c) sectional view of the assembly;
- (d) pictorial sketch;
- (e) parts list; and,
- (f) a small business plan to encompass design justification and conditions.

SCHOOL- BASED ASSESSMENT
ASSESSMENT PLAN
EXEMPLAR 1 – Mechanical Drawing

This School-Based Assessment is aligned to Draw and Interpret Sketches and Simple Drawings (MEMCOR0091A) in the Metal Work Engineering, Level I (CCMEM10302) Regional Occupational Standard.

CANDIDATE: _____ **ASSESSOR:** _____

Elements:

- Prepare freehand sketch.
- Interpret details from freehand sketch.
- Select correct technical drawing.
- Identify drawing requirements.
- Prepare or make changes to engineering drawing.

ALL UNDIMENSIONED RADII $\frac{1}{4}$ "

BEARING ASSEMBLY

PART No.	No OFF	DESCRIPTION	MTL.
1	1	BRACKET	M. S.
2	1	BRACKET	C. I.
3	2	BUSH	R. BRONZ.

Work Activities	Assessment Methods
<p>Your client has presented you with a working drawing to provide a completed assembled drawing with a detailed parts list. Your drawing with print title, symbol of projection, scale and full dimension must show a suitable pin position and be complete with the following views:</p> <ul style="list-style-type: none"> - a sectional front elevation; - an end elevation; and - a plan. 	<ul style="list-style-type: none"> • Practical demonstration. • Oral questions. • Drawing evaluation.

Underpinning Knowledge and Skills	Range
<ul style="list-style-type: none"> • <i>Measurements. Ability to estimate and measure accurately.</i> • <i>Simple Drawings. Ability to read and interpret them.</i> • <i>Drawing Tools. Ability to recognise them and use them accurately.</i> • <i>Lines. Ability to differentiate between alphabet of lines, line type variation, order of usage and application on drawings.</i> • <i>Scale and proportion. Apply types of scale and proportion to measurements on drawings.</i> • <i>Symbols, dimensions and terminology. Apply to types of drawings.</i> 	<ul style="list-style-type: none"> • <i>Technical drawings may utilise perspective, exploded views or hidden view.</i> • <i>Multi-view full scale (orthographic 2-D) drawings that show all hidden features and centerlines.</i> • <i>Measurement systems (inch/foot system and metric [SI] system).</i> • <i>Alphabet of line (object line, hidden line, centre line, section line, dimension, extension line, cutting line, short break line, phantom line).</i> • <i>Geometric construction to include (circles, regular polygons with four, seven and eight sides, pentagon inscribed within measured circle, ellipse, triangles with specified angles, arcs through three points tangent to two and circles).</i>
<p>Candidate's Signature: _____ Date: _____</p> <p>Assessor's Signature: _____ Date: _____</p> <p>Internal Verifier's Signature: _____ Date: _____</p>	

EXEMPLAR 1 – Mechanical Drawing
DIMENSIONS OF COMPETENCY

This School-Based Assessment is aligned to Draw and Interpret Sketches and Simple Drawings (MEMCOR0091A) in the Metal Work Engineering, Level I (CCMEM10302) Regional Occupational Standard.

WORK ACTIVITY:	
<p>Your client has presented you with a working-drawing to provide a completed assembled drawing with a detailed parts list. Your drawing with print title, symbol of projection, scale and full dimension must show a suitable pin position and be complete with the following views:</p> <ul style="list-style-type: none"> - a sectional front elevation; - an end elevation; and - a plan. 	
TASK SKILLS	TASK MANAGEMENT SKILLS
<p>Candidate has to...</p> <ul style="list-style-type: none"> • Interpret activity • Follow health and safety requirements • Select and accurately use the necessary tools, equipment • Measure accurately within the prescribed scale • Demonstrate appropriate use of lines • Use appropriate drawing techniques • Prepare and present accurate parts list • Prepare and present accurately assembled drawings 	<p>Prepare/organise/ co-ordinate by...</p> <ul style="list-style-type: none"> • Interpret and plan activity • Select tools, equipment and materials • Apply health and safety procedures • Organise work station • Work in a logical and sequential manner within the required time frame • Prepare and present drawings in keeping with clients expectations
CONTINGENCY MANAGEMENT SKILLS	EMPLOYABILITY/ JOB ROLE/ ENVIRONMENT SKILLS
<p>What if ...?</p> <ul style="list-style-type: none"> • The required software is unavailable • The tools and equipment needed are malfunctioning or in adequate 	<p>The candidate can ...</p> <ul style="list-style-type: none"> • Collect, analyse and organise information • Communicate ideas and information • Plan and organise activities • Work with others and in team • Use mathematical ideas and techniques • Solve problems • Use technology

Assessor's Signature: _____

Date: _____

KEY
 Competent - Range 3 and above
 Not Yet Competent - below Range 3

**EXEMPLAR 1 – Mechanical Drawing
 ASSESSOR EVALUATION**

This School-Based Assessment is aligned to Draw and Interpret Sketches and Simple Drawings (MEMCOR0091A) in the Metal Work Engineering, Level I (CCMEM10302) Regional Occupational Standard.

Institution/ Centre: _____

Candidate's Name: _____

ASSESSMENT CRITERIA	ASSESSOR				
	1	2	3	4	5
1. DRAWING					
<i>Sketch is to depict object or part correctly and appropriately drawn</i>					
<i>Correctly and appropriately drawn</i>					
<i>Depicts object or part accurately</i>					
<i>Dimensions are obtained correctly</i>					
<i>Dimensions are shown clearly</i>					
<i>Instructions are shown clearly</i>					
<i>Base line or datum point is indicated</i>					
<i>Components, assemblies or objects are recognised</i>					
<i>Dimensions identified are appropriate</i>					
<i>Instructions are identified and followed</i>					
<i>Material requirements are identified</i>					
<i>Symbols are recognised in sketch</i>					
<i>Drawing is checked and validated against job requirements or equipment</i>					
<i>Drawing version is checked and validated</i>					
<i>Requirements and purpose of drawing is determined from customer and/or work specification and associated documents</i>					
<i>Identified and collected all data necessary to produce the drawing</i>					
<i>Drawing requirements are confirmed with relevant personnel and timeframes for completion established</i>					
<i>Selected appropriate drafting equipment for engineering drawing</i>					
<i>Drafting principles applied to produce a drawing that is consistent with industry standards</i>					
<i>All work is undertaken to prescribed procedure</i>					
<i>Completed drawing is in accordance with standard operating procedures</i>					
<i>Lettering done to standard</i>					
<i>Title block represent required information</i>					
2. DETAILED PARTS LIST					
<i>List includes all required sections</i>					
<i>Items are accurately named/identified with correct spelling</i>					
<i>Dimension of the items included are accurate</i>					
<i>All required items accounted for on list</i>					
<i>Items on list accurately quantified</i>					
<i>Symbols appropriately used where necessary</i>					

Comment/ Feedback:

Rating Scale:

1. Cannot perform this task.
2. Can perform this task with **constant** supervision and **considerable** assistance.
3. Can perform this task with **constant** supervision and **some** assistance.
4. Can perform this task satisfactorily with periodic supervision.
5. Can perform this task satisfactorily with little or no supervision.

Assessor's Signature: _____

Date: _____

Candidate's Signature: _____

Date: _____

**SCHOOL-BASED ASSESSMENT
ASSESSMENT PLAN
EXEMPLAR 2 – Building Drawing**

This School-Based Assessment is aligned to Draw and interpret simple drawings (BCGCOR0031A) in the General Construction, Level I (CCBCG10102) Regional Occupational Standard.

CANDIDATE: _____ ASSESSOR: _____

Elements:

- | | |
|---|---|
| <ul style="list-style-type: none">• Prepare for drawing• Draw geometric constructions• Construct multi-view (orthographic 2-D) drawing• Develop a pictorial (3D) drawing | <ul style="list-style-type: none">• Construct and dimension Drawings• Apply notes and leaders• Prepare freehand sketch• Interpret details from sketches and drawings |
|---|---|

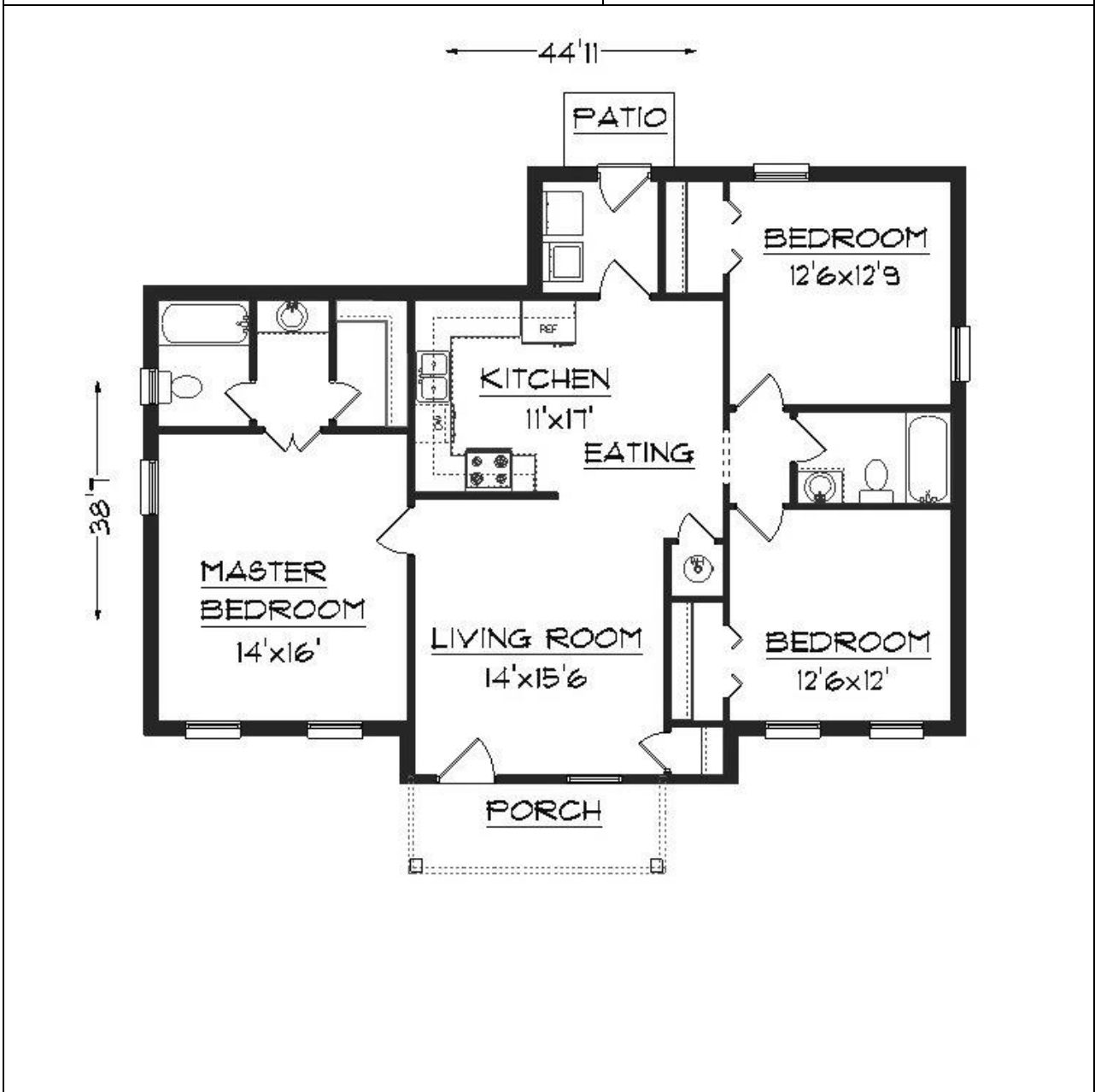

Work Activities	Assessment Methods
<p>Your client has presented you with a floor plan of a three-bedroom house to be completed. Your drawing, with print title, scale and full dimensions must be completed with the following:</p> <ul style="list-style-type: none"> • front elevation taken from the direction of the porch; • side elevation from the left of the porch; and • roof plan to show the design of the roof and roof members. 	<ul style="list-style-type: none"> • Practical demonstration. • Oral questions. • Drawing evaluation.
Underpinning Knowledge and Skills	Range
<ul style="list-style-type: none"> • Measurements. Ability to estimate and measure accurately. • Simple Drawings. Ability to read and interpret them. • Drawing Tools. Ability to recognise them and use them accurately. • Lines. Ability to differentiate between alphabet of lines, line type variation, order of usage and application on drawings. • Scale and proportion. Apply types of scale and proportion to measurements on drawings. • Symbols, dimensions and terminology. Apply to types of drawings. • Prepare technical drawings with drawing instruments and with Auto CAD. 	<ul style="list-style-type: none"> • Technical drawings may utilise perspective, exploded views or hidden view. • Multi-view full scale (orthographic 2-D) drawings that show all hidden features and centerlines. • Measurement systems (inch/foot system and metric [SI] system). • Alphabet of line (object line, hidden line, centre line, section line, dimension, extension line, cutting line, short break line, phantom line). • Scales. Architectural, metric, engineering and civil. • Geometric construction to include (circles, regular polygons with four, seven and eight sides, pentagon inscribed within measured circle, ellipse, triangles with specified angles, arcs through three points tangent to two and circles). • Drawing Dimensions (2D). Dimensioning complex shapes: spheres, cylinders, tapers, and pyramids. • Drawing Dimensions (3D). Full scale (1:1) basic isometric drawing. Isometric corner with left and right side lines each 30 degrees up from horizontal and third line at a vertical, with all three lines joining in a common intersection.
<p>Candidate's Signature: _____ Date: _____</p> <p>Assessor's Signature: _____ Date: _____</p> <p>Internal Verifier's Signature: _____ Date: _____</p>	

EXEMPLAR 2 – Building Drawing
DIMENSIONS OF COMPETENCY

This School-Based Assessment is aligned to Draw and interpret simple drawings (BCGCOR0031A) in the General Construction, Level I (CCBCG10102) Regional Occupational Standard.

WORK ACTIVITY:	
<p>Your client has presented you with a floor plan to provide completed elevations and a roof plan. Your drawing with print title, scale and full dimension must show the following:</p> <ul style="list-style-type: none"> - a front elevation taken from the direction of the porch; - a side elevation taken from the left of the porch; and - a roof plan to show the design of the roof and roof members. 	
TASK SKILLS	TASK MANAGEMENT SKILLS
<p>Candidate has to...</p> <ul style="list-style-type: none"> • Interpret activity • Follow health and safety requirements • Select and accurately use the necessary tools, equipment • Identify and understand various types of drawings • Identify alphabet of lines, scales, lettering, dimensions, symbols, abbreviations and key features • Identify title panel and reference date of drawings • Measure accurately within the prescribed scale • Demonstrate appropriate use of lines • Use appropriate drawing techniques • Prepare and present accurate elevations • Prepare and present accurate roofing plan 	<p>Prepare/organise/co-ordinate by...</p> <ul style="list-style-type: none"> • Interpret and plan activity • Select tools, equipment and materials • Apply health and safety procedures • Organise work station • Work in a logical and sequential manner within the required time frame • Present and present drawings in keeping with clients expectations
CONTINGENCY MANAGEMENT SKILLS	EMPLOYABILITY/ JOB ROLE/ ENVIRONMENT SKILLS
<p>What if ...?</p> <ul style="list-style-type: none"> • The required software is unavailable • The tools and equipment needed are malfunctioning or in adequate 	<p>The candidate can ...</p> <ul style="list-style-type: none"> • Collect, analyse and organise information Level 1 • Communicate ideas and information Level 1 • Plan and organise activities Level 1 • Work with others and in team Level 1 • Use mathematical ideas and techniques Level 1 • Solve problems Level 1 • Use technology

Assessor's Signature: _____

Date: _____

<p>KEY Competent - Range 3 and above Not Yet Competent - below Range 3</p>
--

**EXEMPLAR 2 – Building Drawing
 ASSESSOR EVALUATION**

This School-Based Assessment is aligned to Draw and interpret simple drawings (BCGCOR0031A) in the General Construction, Level I (CCBCG10102) Regional Occupational Standard.

Institution/ Centre : _____

Candidate's Name : _____

ASSESSMENT CRITERIA	ASSESSOR				
	1	2	3	4	5
1. DRAWING					
<i>Sketch appropriately drawn with applicable views</i>					
<i>Correctly and appropriately drawn</i>					
<i>Depicts object or part accurately</i>					
<i>Dimensions are obtained correctly</i>					
<i>Dimensions are shown clearly</i>					
<i>Instructions are shown clearly</i>					
<i>Base line or datum point is indicated</i>					
<i>Components or objects are recognised</i>					
<i>Dimensions identified are appropriate</i>					
<i>Instructions are identified and followed</i>					
<i>Material requirements are identified</i>					
<i>Symbols are recognised in sketch</i>					
<i>Drawing is checked and validated against job requirements or equipment</i>					
<i>Drawing version is checked and validated</i>					
<i>Requirements and purpose of drawing are determined from customer and/or work specification and associated documents</i>					
<i>Identified and collected all data necessary to produce the drawing</i>					
<i>Drawing requirements are confirmed with relevant personnel and timeframes for completion established</i>					
<i>Selected appropriate drafting equipment for building drawing</i>					
<i>Drafting principles applied to produce a drawing that is consistent with industry standards</i>					
<i>All work is undertaken to prescribed procedure</i>					
<i>Completed drawing is in accordance with standard operating procedures</i>					
<i>Lettering done to standard</i>					
<i>Title block represent required information</i>					
<i>Completed drawing illustrates correct application of notes and leaders.</i>					
2. ROOFING PLAN					
<i>Roof design is appropriate for the layout of the building</i>					
<i>Roof members are accurately named/identified with correct spelling</i>					
<i>Dimension of roof members is included and are accurate</i>					
<i>All required roof members are accounted for on the plan</i>					
<i>Symbols appropriately used where necessary</i>					

Comment/ Feedback:

Rating Scale:

1. Cannot perform this task.
2. Can perform this task with **constant** supervision and **considerable** assistance.
3. Can perform this task with **constant** supervision and **some** assistance.
4. Can perform this task satisfactorily with periodic supervision.
5. Can perform this task satisfactorily with little or no supervision.

Assessor's Signature : _____

Date: _____

Candidate's Signature : _____

Date: _____

◆ RESOURCES

- Duncan, M.L. *Second Steps in Technical Drawing*. Trinidad: DCT Publishers, 1998.
- Goetsh, D.E., Nelson, J., and Chalk, W.S. *Chalk Technical Drawing*, 4th Edition. New York: Delmar Publishers, 2000.
- Maguire, D. and Simmons C. *A Manual of Engineering Drawing*. London: Edward Arnold, 1995.
- Morling, K. *Geometric and Engineering Drawing*, 2nd Edition. London: Edward Arnold, 1974.
- Ezeji, S.C. and Nwoke, G.I. *Technical Drawing 3: Building Drawing*. Longman International, 1992.
- Yarwood, A. *Technical Drawing With Design: The Motivate Series*. London: The Macmillan Press Ltd, 1994.

WEBSITES

<http://www.technologystudent.com/>
www.smartdraw.com
www.autodesk.com

◆ GLOSSARY OF TERMS

<u>WORD/TERM</u>	<u>DEFINITION/MEANING</u>
account for	Present reason for action or event
annotate	add a brief note to a label
apply	use knowledge of principles to solve problems
assess	present reasons for the importance of particular structures, relationships or process
calculate	arrive at the solution to a numerical problem
classify	divide into groups according to observable characteristics
comment	state opinion or view with supporting reasons
compare	state similarities and differences
construct	use a specific format to make and draw a graph, histogram, pie chart or other representation using data or material provided or drawn from practical investigations, build (for example, a model), draw scale diagram
deduce	make a logical connection between two or more pieces of information; use data to arrive at a conclusion
define	state concisely the meaning of a word or term
demonstrate	show; direct attention to...
describe	provide detailed factual information of the appearance or arrangement of a specific structure or a sequence of a specific process
determine	find the value of a physical quantity
design	plan and present with appropriate practical detail
develop	expand or elaborate an idea or argument with supporting reasons
diagram	simplified representation showing the relationship between components.
differentiate	state or explain briefly those differences between or among items which can be used to define the items or place them into separate categories.
discuss	present reasoned argument; consider points both for and against; explain the relative merits of a case
draw	make a line representation from specimens or apparatus which shows an accurate relation between the parts

estimate	make an approximate quantitative judgement
<u>WORD/TERM</u>	<u>DEFINITION/MEANING</u>
evaluate	weigh evidence and make judgements based on given criteria
explain	give reasons based on recall; account for
find	locate a feature or obtain as from a graph
formulate	devise a hypothesis
identify	name or point out specific components or features
illustrate	show clearly by using appropriate examples or diagrams, sketches
investigate	use simple systematic procedures to observe, record data and draw logical conclusions
label	add names to identify structures or parts indicated by pointers
list	itemise without detail
measure	take accurate quantitative readings using appropriate instruments
name	give only the name of
note	write down observations
observe	pay attention to details which characterise a specimen, reaction or change taking place; to examine and note scientifically
outline	Give basic steps only
plan	prepare to conduct an investigation
predict	use information provided to arrive at a likely conclusion or suggest a possible outcome
record	write an accurate description of the full range of observations made during a given procedure
relate	show connections between; explain how one set of facts or data depend on others or are determined by them
sketch	make a simple freehand diagram showing relevant proportions and any important details
state	provide factual information in concise terms outlining explanations

suggest	offer an explanation deduced from information provided or previous knowledge. (... a hypothesis; provide a generalisation which offers a likely explanation for a set of data or observations.)
test	to find out, following set procedures

**CARIBBEAN EXAMINATIONS COUNCIL
SCHOOL-BASED ASSESSMENT
MARK SCHEME**

SUBJECT: TECHNICAL DRAWING **PROFICIENCY: TECHNICAL** **YEAR:** **CENTRE #:**

CANDIDATE #: **TERRITORY:** **NAME OF TEACHER:**

PRESENTATION /ORGANISATION OF PORTFOLIO

SECTION 1: FUNDAMENTALS OF TECHNICAL DRAWING

KNOWLEDGE	MARKS		APPLICATION	MARKS		PRACTICAL ABILITY	MARKS	
		Max			Max			Max
Knowledge of: <ul style="list-style-type: none"> • Theory of Specific objectives 1.1 – 1.10; • 2.1 and 2.2. 	4		Application of: <ul style="list-style-type: none"> • Theory of Specific objectives 1.1 – 1.10; • 2.1 and 2.2. 	6				
	4			6				0

**CARIBBEAN EXAMINATIONS COUNCIL
SCHOOL-BASED ASSESSMENT
MARK SCHEME**

SUBJECT: TECHNICAL DRAWING **TERRITORY:** **PROFICIENCY: TECHNICAL** **YEAR:** **CENTRE #:**

CANDIDATE #: **NAME OF TEACHER:**

SECTION 2A: PLANE GEOMETRY

KNOWLEDGE	MARKS		APPLICATION	MARKS		PRACTICAL ABILITY	MARKS	
		Max			Max			Max
Reproducing given information (for example, views, measurements)		4	<ul style="list-style-type: none"> Applying correct principles of geometric construction Linework/linetype 		4	<ul style="list-style-type: none"> Accuracy of geometric construction Quality of Line work/line type Dimensions Neatness 		3
		4			7			2
								2
								2
								9

SECTION 2B: SOLID GEOMETRY

KNOWLEDGE	MARKS		APPLICATION	MARKS		PRACTICAL ABILITY	MARKS	
		Max			Max			Max
Reproducing given information (for example, views, measurements)		4	<ul style="list-style-type: none"> Applying correct principles of geometric construction Line work/line type 		4	<ul style="list-style-type: none"> Accuracy of geometric construction Quality of Line work/line type Dimensions Neatness 		3
		4			3			2
					7			2
								2
								9

TOTAL MARKS

KNOWLEDGE	APPLICATION	PRACTICAL ABILITY
	8	14
		18



**CARIBBEAN EXAMINATIONS COUNCIL
SCHOOL-BASED ASSESSMENT
MARK SCHEME**

SUBJECT: TECHNICAL DRAWING **PROFICIENCY: TECHNICAL** **YEAR:** **CENTRE #:**
CANDIDATE #: **TERRITORY:** **NAME OF TEACHER:**

SECTION 3: BUILDING DRAWING

KNOWLEDGE	MARKS		APPLICATION	MARKS		PRACTICAL ABILITY	MARKS	
		Max			Max			Max
Knowledge of:			Principles of:			Practicality of:		
<i>Entrepreneurship Opportunities - Small Business Plan:</i>			<i>Entrepreneurship Opportunities/Small Business Plan:</i>		7	<i>Design</i>		7
<ul style="list-style-type: none"> • <i>Organisation of Portfolio</i> • <i>Statement of the problem</i> • <i>Conditions</i> • <i>Design principles</i> 			<ul style="list-style-type: none"> • <i>Organisation of Portfolio</i> • <i>Statement of the problem</i> • <i>Conditions</i> • <i>Design principles</i> 			<ul style="list-style-type: none"> • <i>Originality</i> • <i>Functionality</i> • <i>Suitability</i> • <i>Conformity to building standards</i> 		
Working Drawings		2	Working drawings		5	Working drawings		6
			Design			<ul style="list-style-type: none"> • Floor Plan • Foundation plan/Roof plan/Details • Elevations • Sectional Elevations 		4
			<ul style="list-style-type: none"> • Functionality • Suitability of materials • Conforming to building standards 		2			4
			Dimensioning			Dimensions		4
						Dimensioning		4
					2	Techniques		4
						<ul style="list-style-type: none"> • Line work/Quality • Lettering • Symbols 		2
						Neatness/Presentation		2
		5			20			3
								45

**CARIBBEAN EXAMINATIONS COUNCIL
SCHOOL-BASED ASSESSMENT
MARK SCHEME**

SUBJECT: TECHNICAL DRAWING **PROFICIENCY: TECHNICAL** **YEAR:** **CENTRE #:**

CANDIDATE #: **TERRITORY:** **NAME OF TEACHER:**

SECTION 4: MECHANICAL DRAWING

KNOWLEDGE	MARKS		APPLICATION	MARKS		PRACTICAL ABILITY	MARKS				
		Max			Max			Max			
Knowledge of: <i>Entrepreneurship Opportunities - Small Business Plan:</i> <ul style="list-style-type: none"> • <i>Organisation of Portfolio</i> • <i>Statement of the problem</i> • <i>Conditions</i> • <i>Design principles Statement of the problem</i> 	3		Principles of: <i>Entrepreneurship Opportunities - Small Business Plan:</i> <ul style="list-style-type: none"> • <i>Organisation of Portfolio</i> • <i>Statement of the problem</i> • <i>Conditions</i> • <i>Design principles</i> 	7		Accuracy of: Design <ul style="list-style-type: none"> • <i>Originality</i> • <i>Functionality</i> • <i>Suitability</i> • <i>Conformity to BS International standards/ISO 9000</i> • <i>Design</i> 	7				
Working Drawings	2		Working Drawings <ul style="list-style-type: none"> • Parts sheet • Pictorial • Sectional view of the assembly • Elevation/Plan of the assembly • Parts list 	5		Working Drawings <ul style="list-style-type: none"> • Parts sheet • Pictorial • Sectional view of the assembly • Elevation/Plan of the assembly • Parts list 	5	3	6	5	2
			Design <ul style="list-style-type: none"> • Function • Safety • Suitability of materials 		2	Dimensions Dimensioning Techniques	4			2	

KNOWLEDGE (cont'd)	MARKS		APPLICATION (cont'd)	MARKS		PRACTICAL ABILITY (cont'd)	MARKS	
		Max			Max			Max
Knowledge of:			Principles of:			Accuracy of: Line work/Line types		
						<ul style="list-style-type: none"> • Outline • Centre Line • Hidden Line • Section Line 		4
			Dimensioning		2	Text/Print <ul style="list-style-type: none"> • Name of Project • Projection symbols 		2 2
		5				Neatness/CAD presentation		3
					20			45

Portfolio Development Guidelines

A portfolio is an organised convenient means of collection and presentation of materials which records and verifies a candidate's learning achievements and relates them to the depth and breadth of work required by each unit of the occupational standards. The depth and breadth of work should include a diversity of exhibits which reflects the following **criteria**:

- Writing, Reading and Comprehension Skills
- Critical Thinking and Problem Solving Skills
- Technology Skills
- Practical Skills
- Teamwork Skills

The outline of the portfolio should include information under the following headings:

- Cover Page
- Title Page
- Table of Contents
- Introduction
- Supporting Evidence (Depth & Breadth of Work)
- Self Assessment/Reflection

Details of EACH Heading

Cover Page

- Name of School
- Occupational Area CVQ Level 1
- Assessors Name
- Candidate's Name
- Year

Title Page

- Caribbean Vocational Qualification
- CVQ Level 1
- Occupational Area
- Year

Table of Contents

- By units
- Number pages

Introduction

- Portfolio of candidate to include personal data, background information on education / training experiences and expectations.

Supporting Evidence

Provides information on the key formative and summative assignments / projects undertaken by the candidates to achieve the performance criteria in each unit on the Occupational Standards. All evidence supplied by the candidate should be reviewed by the assessor using the **criteria given**. **Evidence must be signed and dated on the date of the review by the assessor.**

Suggestions for supporting evidence:

- Written Assignment
- Oral Questions (checklist format)
- Projects
- Work Samples
- Research Assignments
- Fieldtrip reports
- Summative evaluation of practical work
- Digital photographs of candidates performing critical tasks

Self-Assessment/Reflections

Allows candidates to rate their performance against the requirements of the relevant unit/s of competency and allows candidates to reflect in writing whether their expectations have been achieved in the particular occupational area.

Summary

Each candidate in every occupational area *must* prepare a portfolio which will showcase:

- Growth and development of the candidate during the two year period.

Portfolios *must* be kept for evaluation by the Internal Verifier, External Verifier and the Quality Assurance auditor of the Caribbean Examination Council.

GUIDELINES FOR THE DELIVERY AND ASSESSMENT OF THE SCHOOL-BASED ASSESSMENT USING THE PRINCIPLES OF COMPETENCY BASED EDUCATION, TRAINING AND ASSESSMENT (CBETA)

An Internal Verifier is recommended for the Technical Drawing Course. This is an internal person in the institutions responsible for ensuring the quality of the delivery and assessment of all the Sections of the Syllabus and the CVQ Units of Competence for the SBA and the SBA portfolio. The internal verifier assists the teachers/facilitators in the preparation of the delivery and assessment schedules; monitor the progress of portfolios as well as teachers/facilitators and students' record keeping. They support and work at ensuring accuracy and consistency and effectiveness of the learning experiences. They work collaboratively with the external verifiers assigned to the institutions.

Principals or other administrative personnel and teachers/facilitators are encouraged to use the following guidelines in achieving the requirements for the award of the Level 1 CVQ Unit Certification required for the SBA.

1. *Prior to the commencement of delivery of the syllabus:*
 - (a) *access the Regional Occupational Standards to which this syllabus is aligned from the CANTA website (www.cantaonline.org);*
 - (b) *verify if there are trained external verifiers available;*
 - (c) *ensure that teachers/facilitators are trained assessors;*
 - (d) *ensure that internal verifiers are trained;*
 - (e) *clarify all concerns about the CVQ, relevant procedures and documentation required for the training, delivery, assessment and verification processes and final documents required for submission to CXC.*
2. *Place substantial reliance on evidence to make judgements on the quality of students' performance;*
3. *Engage in a flexible schedule of continuous teaching and assessment until mastery of competency is demonstrated. The assessment is an integral part of the learning process as well as a means of evaluating it;*
4. *Maintain evidence of students' learning through the use of the internal and external verification systems required for the delivery and assessment of the CVQ.*

PORTFOLIO ASSESSMENT

The portfolio is a student-centred communication approach that adequately reflects the teaching and learning experiences through authentic activities. This assessment provides teachers/facilitators with an opportunity to participate in the progress of the students in a very broad context. This may include the observation of the students in exploring, experimenting, taking risks, developing creative solutions and learning to access or make judgements (competent or developing competency) about their own performances. The portfolio places a high premium on quality. It provides a strong

feedback loop of continuous evaluation and improvement in teaching and learning. It is one of the major quality assurance vehicles for the provision of tangible and intangible evidences, attesting to the quality (relevance, validity, reliability) of educational delivery, assessment and outputs.

Portfolio Assessment is multi-dimensional in nature and has the following characteristics of quality:

- 1. It is continuous and ongoing; providing both formative and summative evaluation opportunities for monitoring the students' progress while they work toward the achievement of the performance outcomes.*
- 2. It uses a wide variety of tangible and intangible evidences (practical and written), reflecting various aspects of the delivery and learning processes.*
- 3. It is reflective, providing students with an opportunity to analyse their performance and track the development of their competencies.*
- 4. The assessment results are used to improve the delivery and learning processes.*
- 5. Contains evidence that represent a variety of assessment methods.*
- 6. Contains the results of assessments of students' work.*

PLANNING THE PORTFOLIO AND ITS EVALUATION

This is a collaborative activity between the teachers/facilitators, students and the verification personnel.

Steps

- 1. Discuss with the students the importance of the portfolio as a means of monitoring, evaluating and making judgment on their progress.*
- 2. Select the entries for the portfolio and establish criteria for its storage and maintenance. Encourage the use of electronic portfolios.*
- 3. Outline and monitor the organisation of the evidence (cover page, table of contents, logical building and exhibition of the artefacts a sequence of the units, literary work, student evaluation, reflection or self-assessment statement and others). (See Appendix 2 for Portfolio Development Guidelines)*
- 4. Develop a completion and evaluation schedule for the portfolio. This is important for enabling completion and recognition of the CVQ Units of Competence. This is a joint activity among the students, teachers/facilitators, internal verifier and external verifier/s and the quality assurance personnel from CXC.*

Western Zone Office
1 April 2015

CARIBBEAN EXAMINATIONS COUNCIL

Caribbean Secondary Education Certificate®



TECHNICAL DRAWING

Specimen Papers and Mark Schemes/Keys

Specimen Papers:

- Paper 01
- Paper 02 (Building Drawing)
- Paper 02 (Mechanical Engineering Drawing)

Mark Schemes and Keys:

- Paper 01
- Paper 02 (Building Drawing)
- Paper 02 (Mechanical Engineering Drawing)



CARIBBEAN EXAMINATIONS COUNCIL
CARIBBEAN SECONDARY EDUCATION CERTIFICATE®
EXAMINATION

TECHNICAL DRAWING

Paper 01 – General Proficiency

75 minutes

READ THE FOLLOWING INSTRUCTIONS CAREFULLY.

1. This test consists of 60 items. You will have 75 minutes to answer them.
2. In addition to this test booklet, you should have an answer sheet.
3. Each item in this test has four suggested answers lettered (A), (B), (C), (D). Read each item you are about to answer and decide which choice is best.
4. On your answer sheet, find the number which corresponds to your item and shade the space having the same letter as the answer you have chosen. Look at the sample item below.

Sample Item

In drawings, thin short dashes represent

- (A) adjacent parts
- (B) hidden details
- (C) movable parts
- (D) irregular details

Sample Answer



The best answer to this item is “hidden details,” so (B) has been shaded.

5. If you want to change your answer, erase it completely before you fill in your new choice.
6. When you are told to begin, turn the page and work as quickly and as carefully as you can. If you cannot answer an item, go on to the next one. You may return to that item later.
7. You may do any rough work in this booklet.
8. Figures are not necessarily drawn to scale.

DO NOT TURN THIS PAGE UNTIL YOU ARE TOLD TO DO SO.

1. In an isometric sketch, circles and arcs will appear as

- (A) segments
- (B) round, smooth lines
- (C) ellipses or part of ellipses
- (D) round arcs without distortions

2. Which of the following instruments is used to draw irregular curves?

- (A) Compass
- (B) Protractor
- (C) Flexicurve
- (D) Radius curve

3. Which of the following drawings shows triangles of equal area between parallel lines?

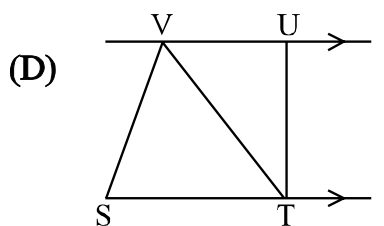
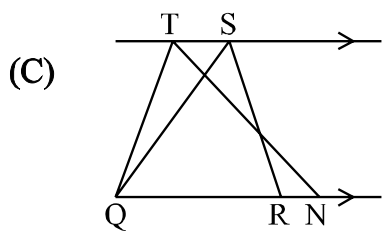
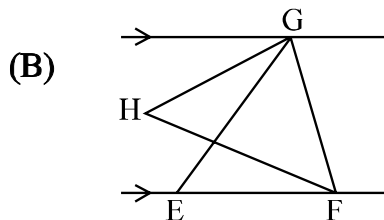
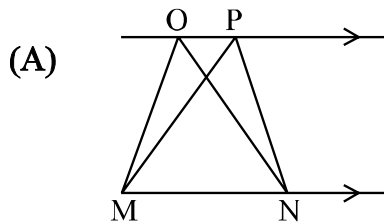

Item 4 refers to the following diagram.

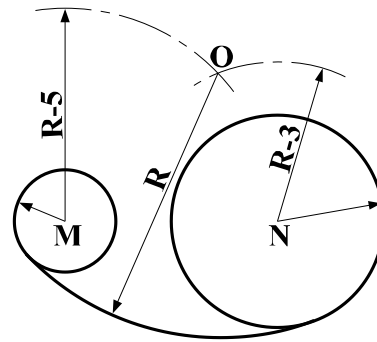

4. In the drawing above, which of the following letters indicates the centre of the arc which is tangential to the two circles?

- (A) M
- (B) N
- (C) O
- (D) R

Item 5 refers to the following views.

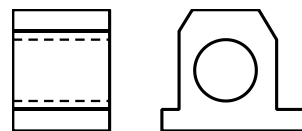

5. Which of the views below shows the plan of the object illustrated in the two views above?

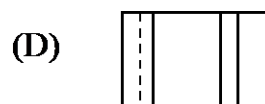
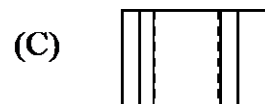
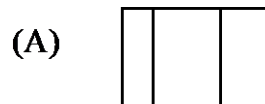

6. Which of the following correctly defines the locus of a point?
- (A) The calculated circumference
 - (B) A point which moves and traces a path
 - (C) The cutting tool attached to the lathe
 - (D) A right-angled triangle wrapped around a cylinder

7. Which of the following circles is correctly dimensioned?

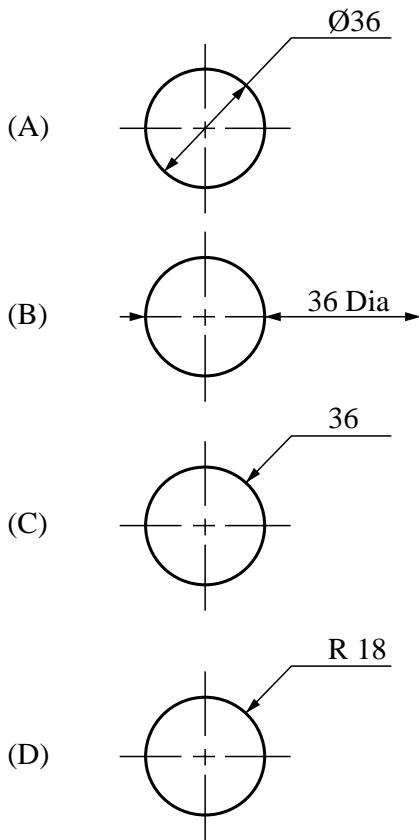

Item 8 refers to the following diagram.

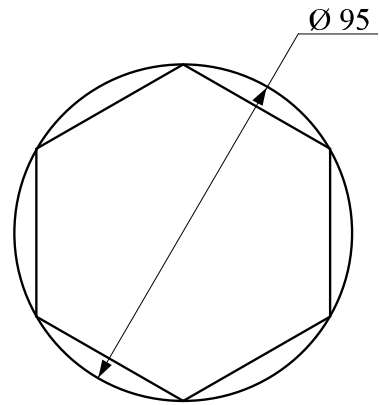

8. The polygon shown above is a regular hexagon of side
- (A) 47.5 mm
 - (B) 50.5 mm
 - (C) 52.5 mm
 - (D) 55.5 mm

Item 9 refers to the following diagram.

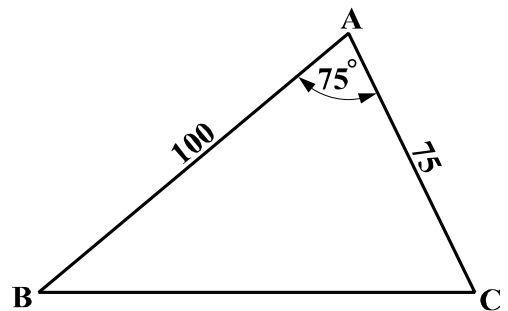

9. The triangle illustrated above can be constructed with the use of
- (A) a ruler and pencil only
 - (B) a compass and protractor only
 - (C) a compass, a ruler and a pencil
 - (D) a set-square, a ruler and protractor

GO ON TO THE NEXT PAGE

10. Which of the following is a view of a right triangular pyramid?

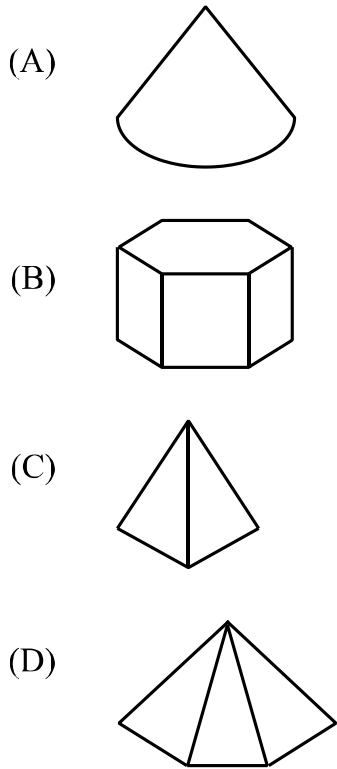

11. Which of the following represents the correct procedure for bisecting an angle of 90° ?

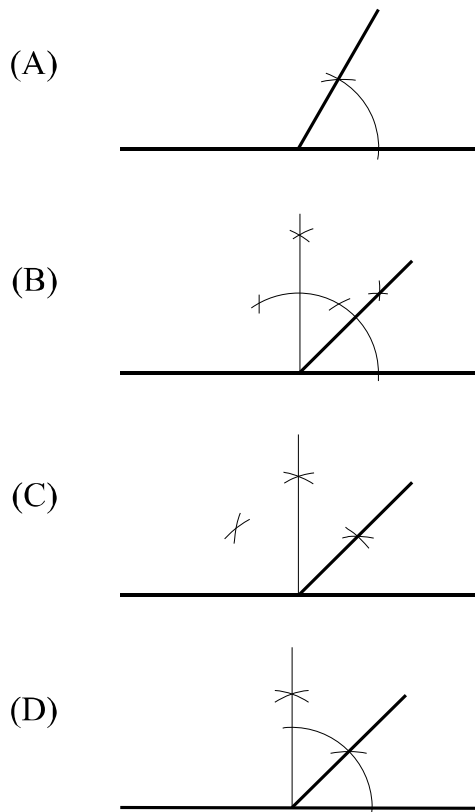

Item 12 refers to the following diagram.

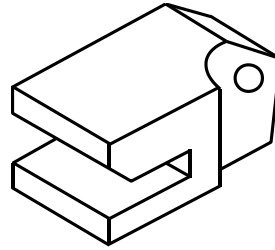

12. Which of the following represents the plan of the drawing above?

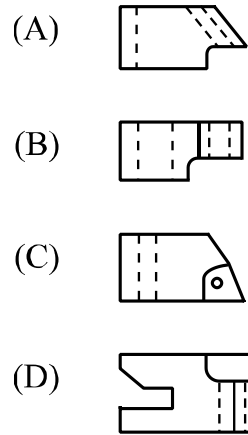

13. Which of the following patterns could be folded to form a truncated square prism having no cover or base?

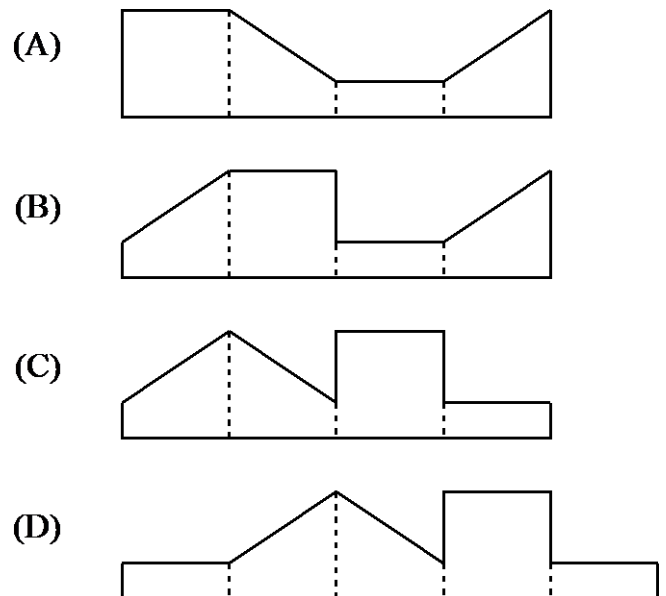

GO ON TO THE NEXT PAGE

14. Which of the following drawings shows a rectangle equal in area to a triangle?

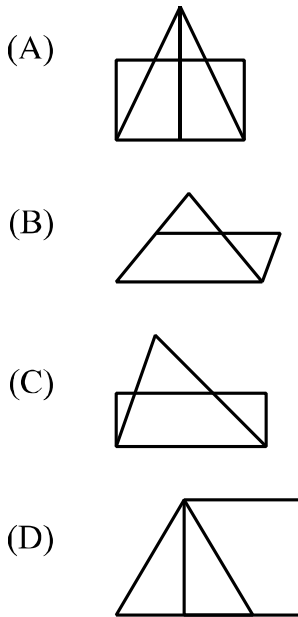

Item 15 refers to the following views.

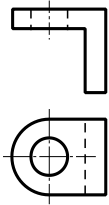

15. Which pictorial view below is represented by the orthographic views shown above?

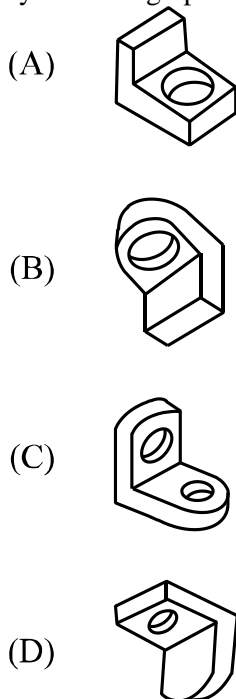

Item 16 refers to the following construction.

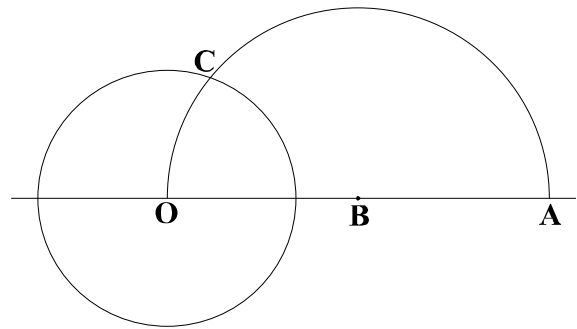

16. The purpose of the construction above, when completed, is to
- (A) draw a tangent to the circle from A
 - (B) draw two tangents to the circle from B
 - (C) draw an arc to pass through three points
 - (D) find the mean proportional to AO and CO

Item 17 refers to the following diagram.

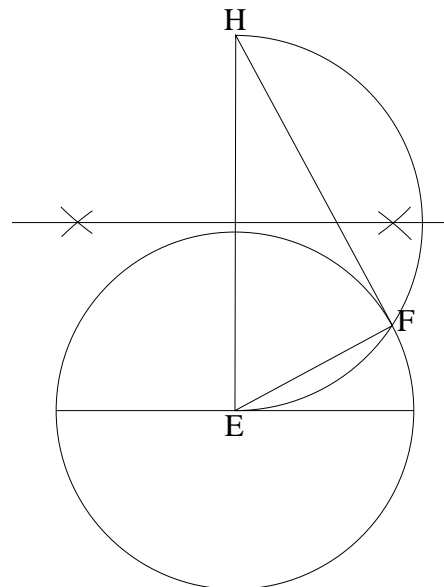

17. In the diagram above, the angle EFH is
- (A) 30°
 - (B) 45°
 - (C) 60°
 - (D) 90°

GO ON TO THE NEXT PAGE

18. A cube with an edge of 80 mm is to be drawn in oblique projection. The length of the receding lines, in mm, should be

- (A) 10
- (B) 20
- (C) 30
- (D) 40

Item 19 refers to the following diagram.

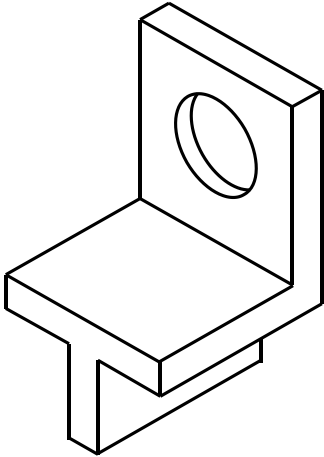

19. Which of the following is a true elevation of the drawing shown above?

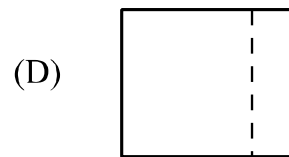
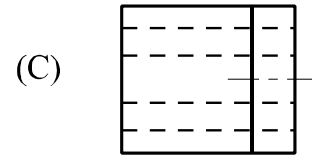
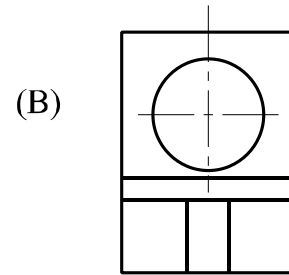
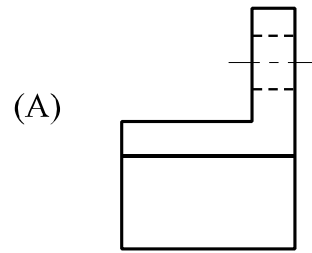

20. Which of the following illustrates the normal of an ellipse?

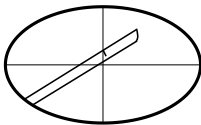
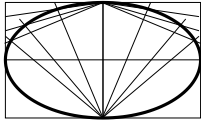
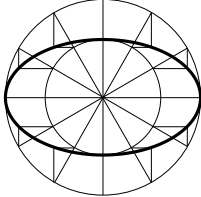
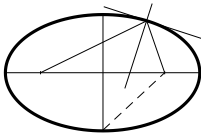
- (A) 
- (B) 
- (C) 
- (D) 

21. 'The spiral of Archimedes' is defined as

- (A) a plane curve generated by a point on a taut chord as it is unwound from the perimeter of a polygon
- (B) the path generated by a point which revolves uniformly about a pole and has a uniform motion away from it
- (C) a plane curve generated by the path of a point on the perimeter of a wheel as the wheel travels on a straight track
- (D) the path generated by a point travelling in a plane such that the difference of its distance from two foci is constant and equal to the transverse axis

22. Which of the following patterns can be folded to form a square prism with an oblique top?

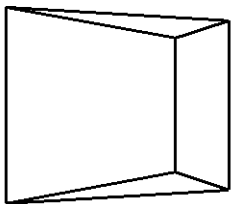
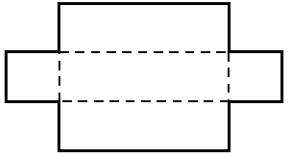
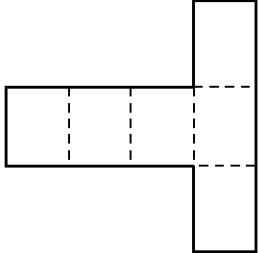
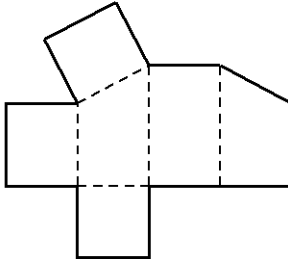
- (A) 
- (B) 
- (C) 
- (D) 

Item 23 refers to the following diagram.

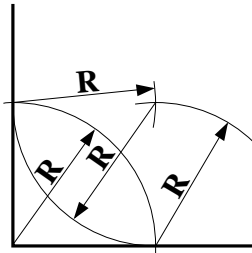

23. The diagram above illustrates the construction of a
- (A) circle tangential to two converging lines
 - (B) tangent from a point outside a given circle
 - (C) circle tangential to two lines at right angles
 - (D) tangent to a circle at a point on its circumference

Item 24 refers to the following diagram.

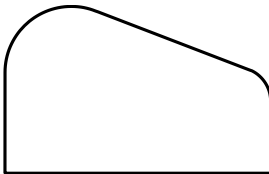

24. The construction used in designing the bending jig illustrated above was that for obtaining a
- (A) tangent joining two arcs
 - (B) common internal tangent
 - (C) tangent to two equal circles
 - (D) tangent from a point outside the circle
25. The point at which the bisectors of the angles of a triangle meet is the centre of
- (A) two given circles
 - (B) the escribed circle
 - (C) the inscribed circle
 - (D) the common tangent

Item 26 refers to the following diagram.

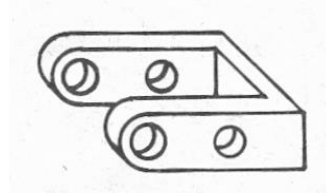

26. The type of projection illustrated above is
- (A) oblique
 - (B) first-angle
 - (C) isometric
 - (D) third-angle

Item 27 refers to the following construction.

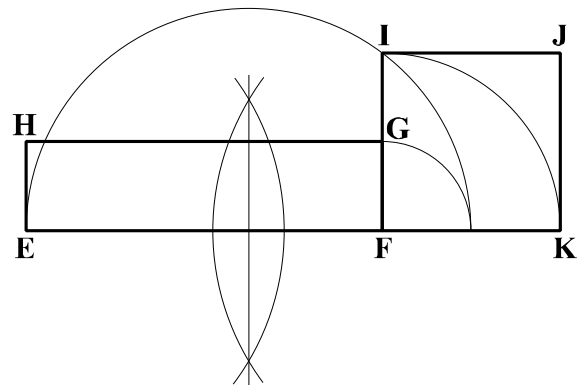

27. Which of the following is TRUE of the construction above?
- (A) IJKF is half the area of EFGH.
 - (B) EFGH is equal in area to IJKF.
 - (C) EFGH is half the area of IJKF.
 - (D) IJKF is twice the area of EFGH.
28. The ANSI, BS and ISO regulations used in technical drawing are referred to as
- (A) local codes
 - (B) building codes
 - (C) regional standards
 - (D) international standards

GO ON TO THE NEXT PAGE

29. When sketching pictorial figures, one should first

- (A) sketch circles
- (B) draw all straight lines
- (C) construct parts separately
- (D) construct a box to hold the figure

30. Which of the following surfaces is developed in the shape of a 'T' by unfolding or unrolling?

- (A) A square pyramid
- (B) A triangular prism
- (C) A rectangular box with lid
- (D) A hexagonal truncated prism

Item 31 refers to the following construction.

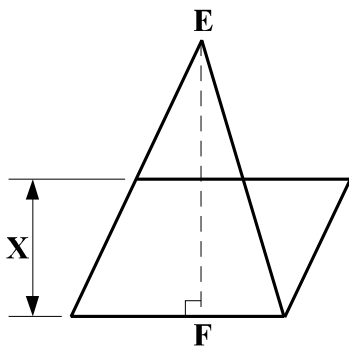

31. The construction above shows how to draw a parallelogram equal in area to a given triangle. If EF is 30, then X is

- (A) 10
- (B) 15
- (C) 20
- (D) 30

Item 32 refers to the following diagram.

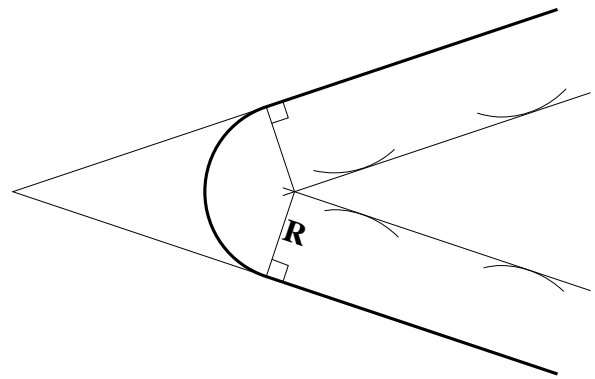

32. The diagram above shows the method of finding the centre of an arc, with radius R, which is tangential to

- (A) two straight lines meeting at right angles
- (B) two straight lines meeting at any angle
- (C) a line and a circle
- (D) a straight line

Item 33 refers to the following diagram.

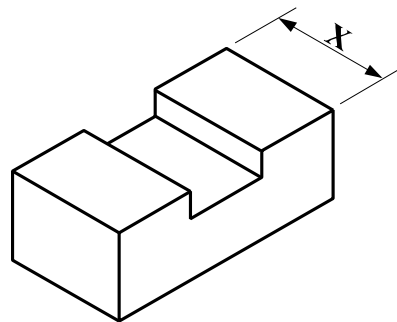

33. The diagram above is to be reproduced in third angle projection. On what views can the distance X be seen?

- (A) Top and front
- (B) Top and right side
- (C) Front and left side
- (D) Front and right side

Item 34 refers to the following diagram.

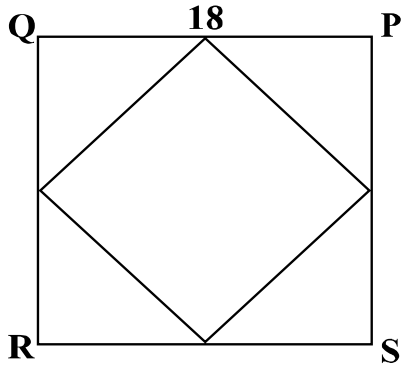

34. The sides of the square QRST above are bisected and the adjacent points are joined to form another square. The area of the new square is
- (A) 72 mm²
 - (B) 81 mm²
 - (C) 162 mm²
 - (D) 324 mm²

Item 35 refers to the following diagram.

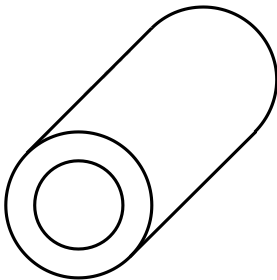

35. In the diagram above, the circles and curves are shown in their true shapes. The method of projection used is
- (A) oblique
 - (B) trimetric
 - (C) isometric
 - (D) orthographic

Item 36 refers to the following diagram.

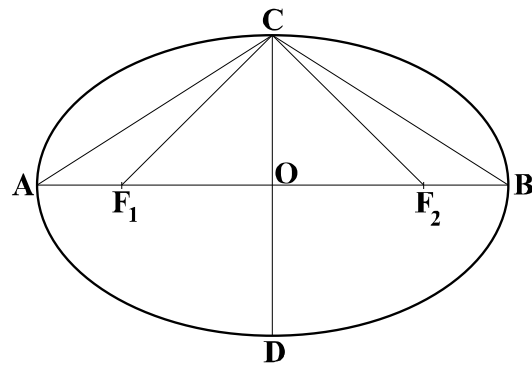

36. In the ellipse above, which sum of distances is equal to AB?
- (A) $F_1C + F_2C$
 - (B) $AC + BC$
 - (C) $F_2C + CD$
 - (D) $F_1C + CB$
37. When designing a new product, which type of drawing is usually made FIRST?
- (A) Scale
 - (B) Sketch
 - (C) Detail
 - (D) Engineering
38. The centre of the circumscribing circle of a triangle can be found by using the
- (A) three medians
 - (B) bisectors of any two sides
 - (C) bisectors of any two angles
 - (D) perpendicular to any side and a median
39. In a perspective drawing, all vertical lines
- (A) have vanishing points
 - (B) pierce the picture plane
 - (C) are toward the point of sight
 - (D) are parallel to the picture plane

GO ON TO THE NEXT PAGE

Item 40 refers to the following diagram.

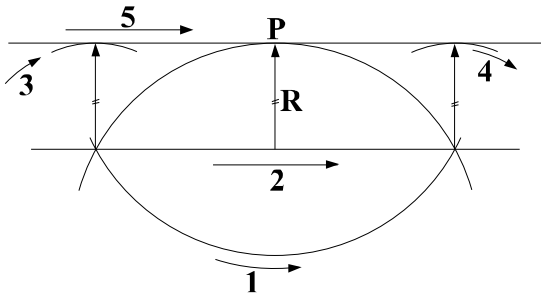

40. The diagram above shows a method of constructing a

- (A) tangent to a circle at a point
- (B) tangent at a point on an arc
- (C) circle passing through a given point
- (D) circle tangential to two converging lines

41. Which of the following scales would be used to produce the smallest drawing of a given object?

- (A) 1:2
- (B) 1:1
- (C) 5:1
- (D) 10:1

Item 42 refers to the following figure.

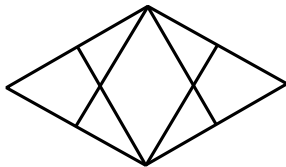

42. The figure above illustrates the start of a method of construction for drawing views of

- (A) circles in perspective drawings
- (B) circles in isometric drawings
- (C) irregular curves in perspective drawings
- (D) irregular curves in orthographic drawings

43. Which of the following drawings represents a truncated prism?

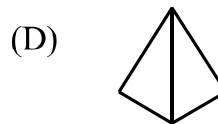
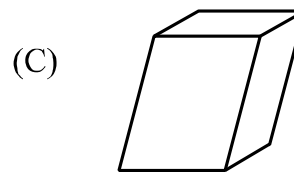
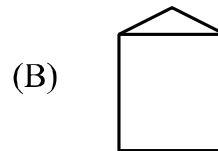
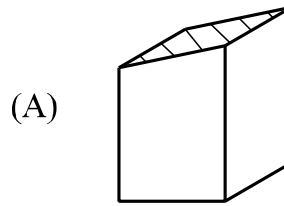

44. On which of the following planes would the plan of an orthographic projection appear?

- (A) Profile
- (B) Vertical
- (C) Auxiliary
- (D) Horizontal

45. Which of the following class of fire extinguishers can be used to put out an electrical fire?

- (A) Class A
- (B) Class B
- (C) Class C
- (D) Class D

Item 46 refers to the following diagram.

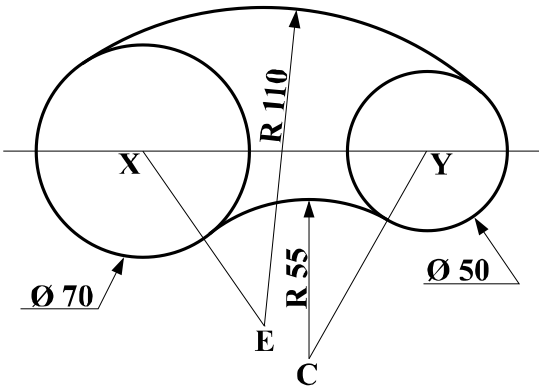

46. In the drawing above, two arcs are drawn tangential to two circles of different radii. What are the lengths of EX and CY respectively?

- (A) 75 and 80
- (B) 80 and 75
- (C) 80 and 105
- (D) 100 and 80

47. The distance between the foci of an ellipse is 24 mm and the length of its minor axis is 18 mm. The length of its major axis, in mm, is

- (A) 26
- (B) 28
- (C) 30
- (D) 32

48. The tolerance for a shaft 18 mm long is +0.055 and -0.063. What is the correct tolerance range?

- (A) 17.045 to 18.063
- (B) 17.055 to 18.063
- (C) 18.055 to 17.937
- (D) 18.550 to 17.937

49. Three circles of varying diameters which touch one another can be drawn if given

- (A) their radii and a line
- (B) two lines and a point
- (C) the position of their centres
- (D) three points through which they pass

50. RS is a straight line. A line segment 25 mm long is marked. Exterior angles of 45° are marked off at each end of the line segment. The two angled lines formed are 25 mm long. If this construction is continued until a closed figure is formed, the figure obtained is

- (A) a pentagon
- (B) a hexagon
- (C) an octagon
- (D) a nonagon

Item 51 refers to the following drawing.

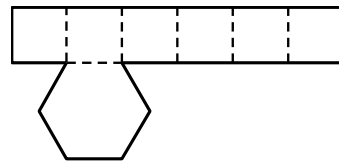

51. The drawing above shows the development of a

- (A) pentagonal box with lid
- (B) hexagonal box with lid
- (C) pentagonal box without lid
- (D) hexagonal box without lid

Item 52 refers to the following elevations.

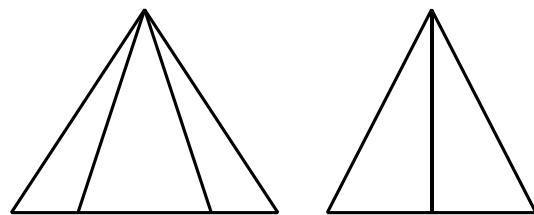

52. The elevations shown above are those of a

- (A) square prism
- (B) square pyramid
- (C) triangular prism
- (D) hexagonal pyramid

53. When a plane figure has a linear reduction only, the

- (A) proportions are changed
- (B) proportions remain the same
- (C) dimensions remain the same
- (D) dimensions and proportions are changed

54. Which of the following drawings represents an escribed circle?

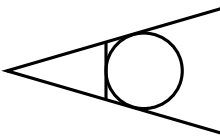
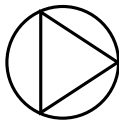
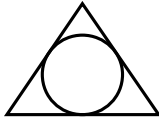
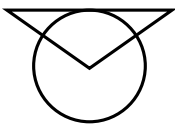
- (A) 
- (B) 
- (C) 
- (D) 

55. Which is the FIRST step that should be taken if a person receives an electric shock in a workshop?

- (A) Turn off the source.
- (B) Activate the fire alarm.
- (C) Remove the person to safety.
- (D) Cover the person with a safety blanket.

Item 56 refers to the following drawing.

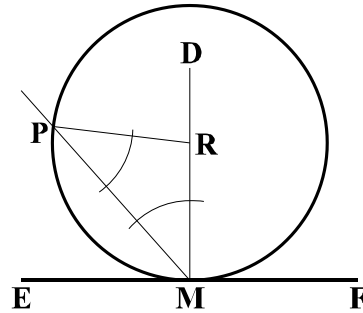

56. In the drawing above, which of the following is NOT true?

- (A) The line RM is equal to the line PR.
- (B) The line DR can be of any length.
- (C) The angle PRM is equal to the angle RPM.
- (D) The angle RMP is equal to the angle RPM.

57. A netball court has a length of 30 m. A line representing this distance on a drawing measures 30 mm. To what scale ratio is the line drawn?

- (A) 1:1000
- (B) 1: 500
- (C) 1: 200
- (D) 1: 100

Item 58 refers to the following drawing.

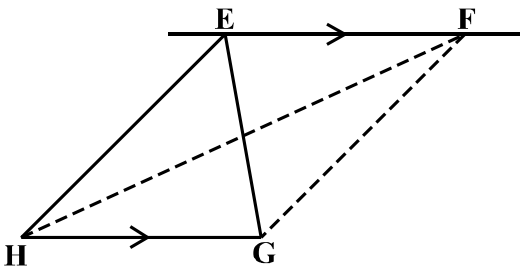

58. Which of the following is TRUE of the drawing above?
- (A) The triangle EGH has been enlarged to a figure which is twice its area.
 - (B) The quadrilateral EFGH has been reduced to a figure having half of its area.
 - (C) The triangles EGH and FGH are equal in area.
 - (D) The quadrilateral EFGH has been changed into a triangle of equal area.

59. Which of the following drawings indicates the correct method of constructing similar triangles?

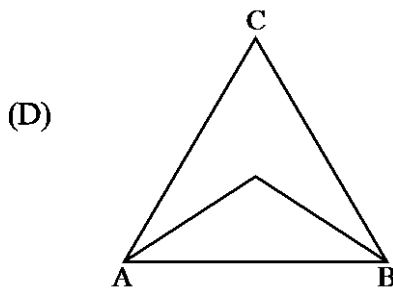
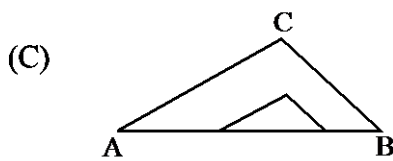
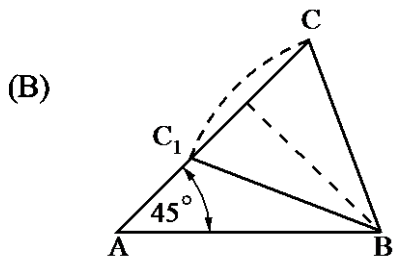
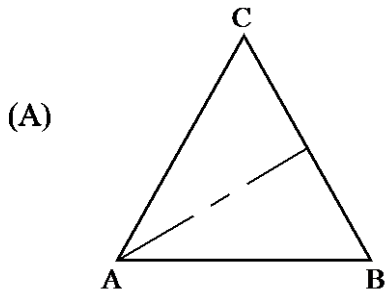

Item 60 refers to the following three views.

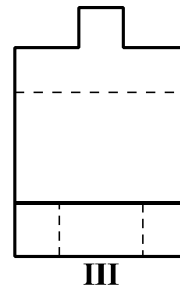
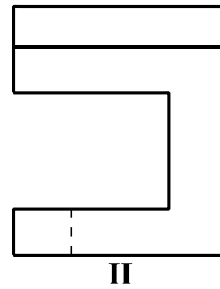
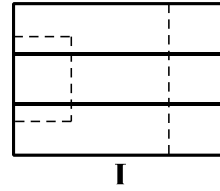

60. The figures above show three views of a block. The front elevation, end view and plan respectively are

- (A) I, III and II
 (B) II, I and III
 (C) II, III and I
 (D) III, II and I

END OF TEST

Item	Key	Syllabus Reference
1	C	2B.1:1.2 (i)
2	C	1.2:2.2
3	A	2A.1:1.1 (iii)
4	C	2A.1:1.2
5	C	2B.1:1.3
6	B	2A.1:1.4
7	A	1.2:2.5
8	A	2A.1:1.1 (v)
9	C	2A.1:1.1 (iii)
10	C	2B.1:1.5
11	B	2A.1:1.1 (ii)
12	B	2B.1:1.3
13	A	2B.1:1.8
14	C	2A.1:1.5
15	B	2B.1:1.1
16	A	2A.1:1.2
17	D	2A.1:1.2
18	D	2B.1:1.2 (ii)
19	A	2B.1:1.3
20	D	2A.1:1.3
21	B	2A.1:1.3
22	D	2B.1:1.8
23	C	2A.1:1.2
24	A	2A.1:1.2
25	C	2A.1:1.1 (vi)
26	A	2B.1:1.2 (ii)
27	B	2A.1:1.6
28	D	1.2:2.1
29	D	2B.1:1.1
30	C	2B.1:1.8
31	B	2A.1:1.6
32	B	2A.1:1.2
33	B	2B.1:1.3
34	C	2A.1:1.1 (iv)
35	A	2B.1:1.2 (ii)
36	A	2A.1:1.3
37	B	1.3:3.1
38	B	2A.1:1.1 (vi)
39	D	2B.1:1.2 (iii)
40	B	2A.1:1.2
41	A	1.2:2.6
42	B	2B.1:1.2 (i)
43	A	2B.1:1.5
44	D	2B.1:1.3
45	C	1.1:1.4
46	A	2A.1:1.2
47	C	2A.1:1.3
48	C	1.2:2.5
49	B	2A.1:1.1 (vi)

Item	Key	Syllabus Reference
50	C	2A.1:1.1 (v)
51	D	2B.1:1.8
52	D	2B.1:1.3
53	B	2A.1:1.7
54	A	2A.1:1.1 (vi)
55	B	1.1:1.6
56	C	2A.1:1.1 (vi)
57	A	1.2:2.6
58	C	2A.1:1.1 (iii)
59	C	2A.1:1.1 (iii)
60	C	2B.1:1.3



TEST CODE **01267020**

SPEC 2015/01267020

C A R I B B E A N E X A M I N A T I O N S C O U N C I L

**CARIBBEAN SECONDARY EDUCATION CERTIFICATE®
EXAMINATION**

TECHNICAL DRAWING – MECHANICAL ENGINEERING DRAWING

SPECIMEN PAPER

Paper 02 – General Proficiency

2 hours 40 minutes

GENERAL INFORMATION

1. Each candidate should have the following for this examination:

Traditional Drawing Method

Two sheets of drawing paper (both sides may be used)
Drawing instruments
Drawing board and T-square
Metric scale rule

Computer-Aided Drafting Method

A minimum of six sheets of size 8½" × 11" OR three sheets of size 11" × 17" paper
Personal computer with monitor, keyboard, mouse and printer
Computer-Aided Drafting software

N.B. ALL solutions to questions attempted for this Option **MUST** be **PRINTED** for submission.

2. All dimensions are given in millimetres unless otherwise stated.
3. When first-angle or third-angle is not specified, the choice of projection is left to the candidate's discretion, in which case the type of projection used **MUST** be clearly stated.
4. Where scales to be employed are not stated, the full size should be applied.
5. The candidate should use his/her own judgement to supply any dimension or detail not directly shown on the drawings.
6. The number of each question answered **MUST** be written next to the solution.
7. Each candidate **MUST** enter his/her school code and registration number in the appropriate space at the bottom right-hand corner of the drawing paper.
8. All geometrical construction lines **MUST** be visible on all answers submitted for **BOTH** Traditional Drawing and Computer-Aided Drafting methods.
9. You are advised to spend 10 minutes to read through the paper and plan your answers.

DO NOT TURN THIS PAGE UNTIL YOU ARE TOLD TO DO SO.

Copyright © 2012 Caribbean Examinations Council
All rights reserved.

This paper consists of TWO questions divided into two sections: Section I, Assembly Drawing and Section II, Sketch and Design. Answer ALL questions.

SECTION I – ASSEMBLY DRAWING

Do NOT spend more than 2 hours on this section.

1. Figure 1, on the enclosed sheet, shows the first-angle orthographic projection details of the parts that make up a Hinge Assembly. In assembly, part (2), the leaf, is fitted over part (1), the base, and is set at right angle (90^0) to it. The parts are fixed by the pin bolt, part (3), and secured by the pin nut, part (4).
- (a) Draw, FULL SIZE, in either first-angle or third-angle orthographic projection, the following views of the assembled parts:
- i. A Plan. Show all hidden details.
 - ii. A full sectional front elevation on cutting plane 'AA'.
- (b) Show SIX main dimensions to include a length, a diameter, a radius and a metric screw thread specification.
- (c) Print the title 'Hinge Assembly' and the scale used. Show the projection method used by symbol.

NOTE: All fillet radii are 3 mm.

[Total 90 marks]

SECTION II – SKETCH AND DESIGN

2. Figure 2 illustrates a simplified method of the sketch of the elevation of a bracket bolted to a frame. The bracket is to be secured using an M12 bolt. Copy the given view inserting the bolt to secure the bracket to the frame. Show ALL constructions for the bolt.

[Total 30 marks]

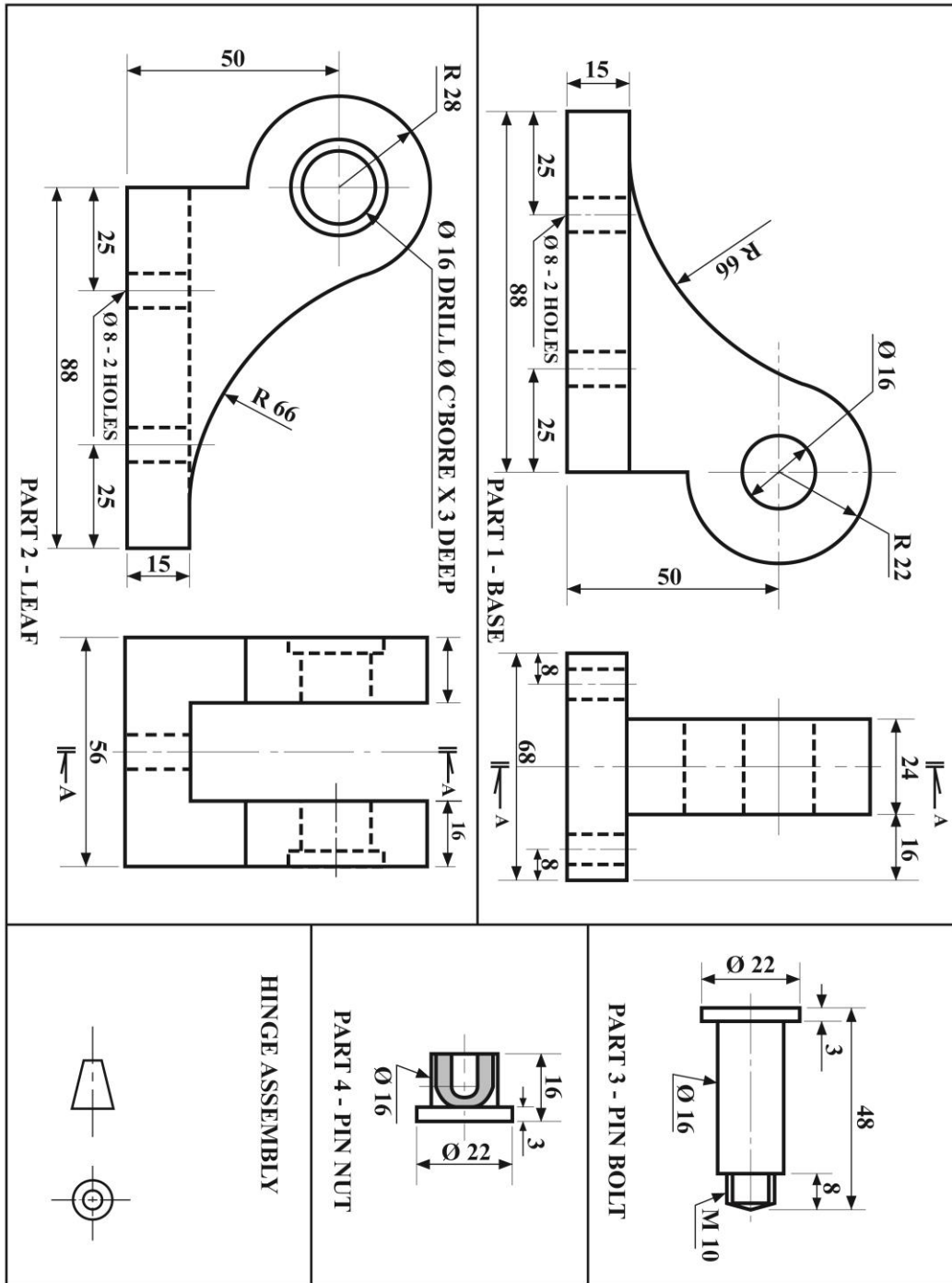

Figure 1

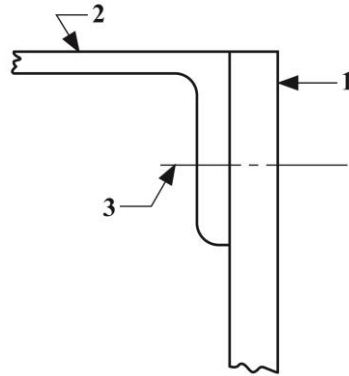

Figure 2

PARTS LIST:

- 1 – Frame (approximately 15 mm thick)**
- 2 – Bracket (approximately 15 mm thick)**
- 3 – Hexagonal nut**

END OF TEST



C A R I B B E A N E X A M I N A T I O N S C O U N C I L

CARIBBEAN SECONDARY EDUCATION CERTIFICATE®
EXAMINATION

TECHNICAL DRAWING

PAPER 02 – GENERAL PROFICIENCY

OPTION – MECHANICAL ENGINEERING DRAWING

SOLUTIONS AND MARK SCHEME

SPECIMEN PAPER 2015

Note: Scoring methods used are the global/holistic method and analytical method.

TECHNICAL DRAWING
PAPER 02
OPTION – MECHANICAL ENGINEERING DRAWING
SOLUTIONS AND MARK SCHEME

QUESTION	KNOWLEDGE	MARKS	APPLICATION	MARKS	PRACTICAL ABILITY	MARKS
1	<p>Knowledge of:</p> <ul style="list-style-type: none"> - Orthographic projection (position of views, alignment of details) - Assembly (plan and sectional elevation) - Details of fasteners (screw thread and nut) - Dimensioning - Conventional symbols (cutting plane, centre line) - Hidden details 	5 5 2 2 2 2	<p>Principles of:</p> <ul style="list-style-type: none"> - Orthographic projection (position of views, alignment of details) - Assembly (plan and sectional elevation) - Cross-hatching (to show different parts) - Fasteners - Dimensioning - Conventional symbols (centre line, cutting plane) - Hidden details 	8 10 4 4 3 4 3	<p>Accuracy of:</p> <ul style="list-style-type: none"> - Orthographic projection (position of views, alignment of details) - Assembly (plan and sectional elevation) - Sectional details - Dimensions - Dimensioning techniques <p>Printing:</p> <ul style="list-style-type: none"> - Title - Scale - Projection method (symbol) - Neatness/CAD presentation - Line work/line type 	8 8 5 4 4 1 1 1 2 2
		18		36		36

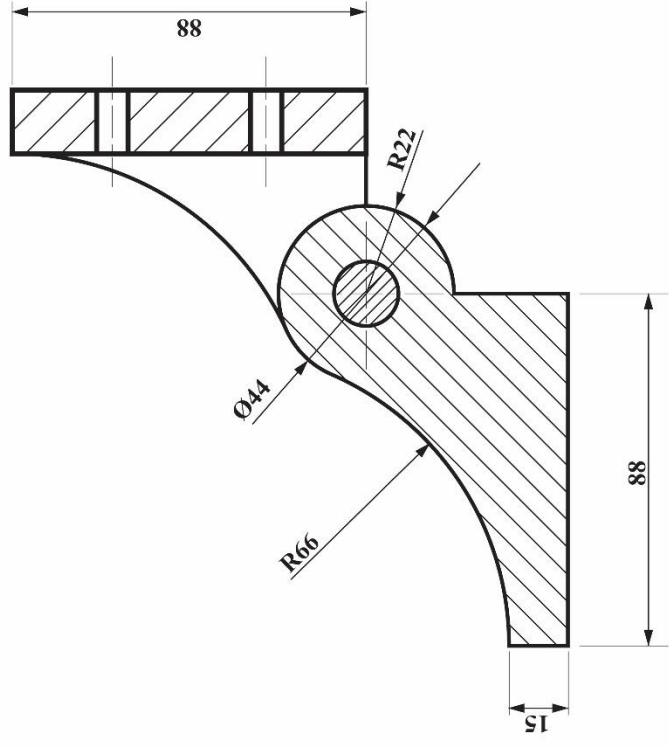

SECTIONAL ELEVATION A - A

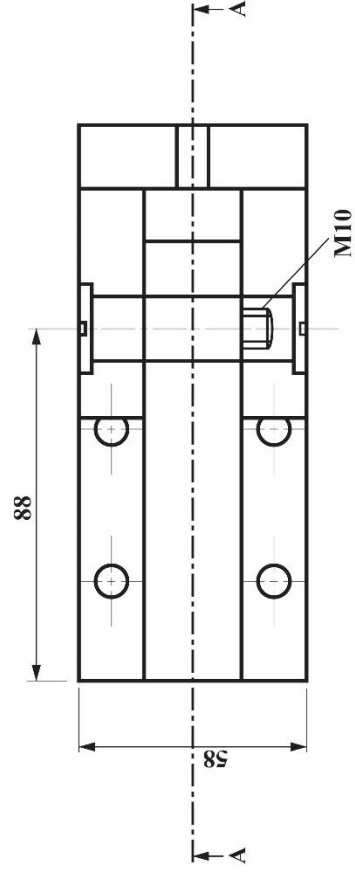

HINGE ASSEMBLY

SOLUTION TO QUESTION 1

TECHNICAL DRAWING
PAPER 02
OPTION – MECHANICAL ENGINEERING DRAWING
SOLUTIONS AND MARK SCHEME

QUESTION	KNOWLEDGE	MARKS	APPLICATION	MARKS	PRACTICAL ABILITY	MARKS
2	Knowledge of: - Orthographic projection: • Given view - Construction of bolt	2 4	Principles of: - Orthographic projection: • Given view - Construction of bolt • Bolt - Dimensions	3 5 3	Accuracy of: - Orthographic projection • Given view - Construction of: • Bolt - Dimensions - Neatness/CAD presentation	3 5 3 2
		4		11		13

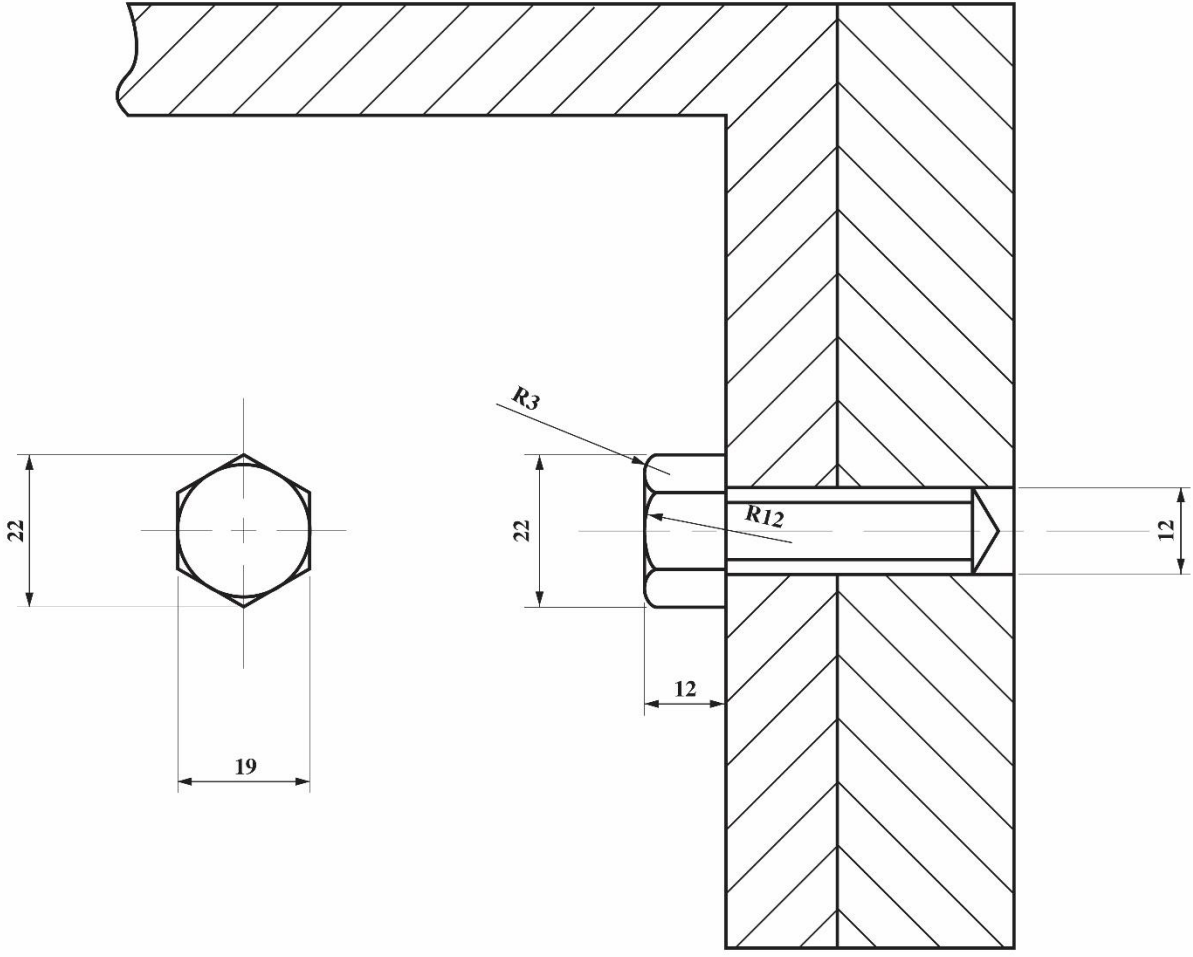



C A R I B B E A N E X A M I N A T I O N S C O U N C I L

CARIBBEAN SECONDARY EDUCATION CERTIFICATE®
EXAMINATION

TECHNICAL DRAWING – BUILDING DRAWING

SPECIMEN PAPER

Paper 02 – General Proficiency

2 hours 40 minutes

GENERAL INFORMATION

1. Each candidate should have the following for this examination:

Traditional Drawing Method

Two sheets of drawing paper (both sides may be used)
Drawing instruments
Drawing board and T-square
Metric scale rule

Computer-Aided Drafting Method

A minimum of six sheets of size 8½" × 11" OR three sheets of size 11" × 17" paper
Personal computer with monitor, keyboard, mouse and printer
Computer-Aided Drafting software

N.B. ALL solutions to questions attempted for this Option MUST be PRINTED for submission.

2. All dimensions are given in millimetres unless otherwise stated.
3. When first-angle or third-angle is not specified, the choice of projection is left to the candidate's discretion, in which case the type of projection used MUST be clearly stated.
4. Where scales to be employed are not stated, the full size should be applied.
5. The candidate should use his/her own judgement to supply any dimension or detail not directly shown on the drawings.
6. The number of each question answered MUST be written next to the solution.
7. Each candidate MUST enter his/her school code and registration number in the appropriate space at the bottom right-hand corner of the drawing paper.
8. All geometrical construction lines MUST be visible on all answers submitted for BOTH Traditional Drawing and Computer-Aided Drafting methods.
9. You are advised to take some time to read through the paper and plan your answers.

DO NOT TURN THIS PAGE UNTIL YOU ARE TOLD TO DO SO

This paper consists of TWO questions divided into two sections: Section I, Working Drawing and Section 2, Sketch and Design. Answer ALL questions.

SECTION I – WORKING DRAWING

Do NOT spend more than 2 hours on this section.

1. Figure 1, on the enclosed sheet, shows a single line outline of the floor plan for a three-bedroom residential structure of block construction. The outline of a continuous sloped roof is shown in broken lines.

(a) Draw, to a scale of 1:50, the roof framing plan for the building, showing clearly the following:

- (i) Building line
- (ii) Layout for the ridge, rafters and laths, showing the thickness of the framing members
- (iii) Overhang (eave)

(b) Label the drawing and give the size of each member.

(c) Print the title 'Roof Framing Plan' and state the scale used.

NOTE: Thickness of roof members must be shown on the roof plan.

Specifications for roof:

Common rafters – 50 mm × 50 mm at 600 mm centre to centre

Ridge – 50 mm × 200 mm

Covering material – asphalt shingles on 19 mm plywood

Close boarding – 19 mm thick tongue and groove boards

Fascia – 31 mm thick × 250 mm

External walls – 170 mm thick

Internal walls – 120 mm thick

Wall plate – 100 mm × 100 mm

[Total 90 marks]

GO ON TO THE NEXT PAGE

SECTION II – SKETCH AND DESIGN

2. The single line floor plan in Figure 1 shows a circle marked 'A'.

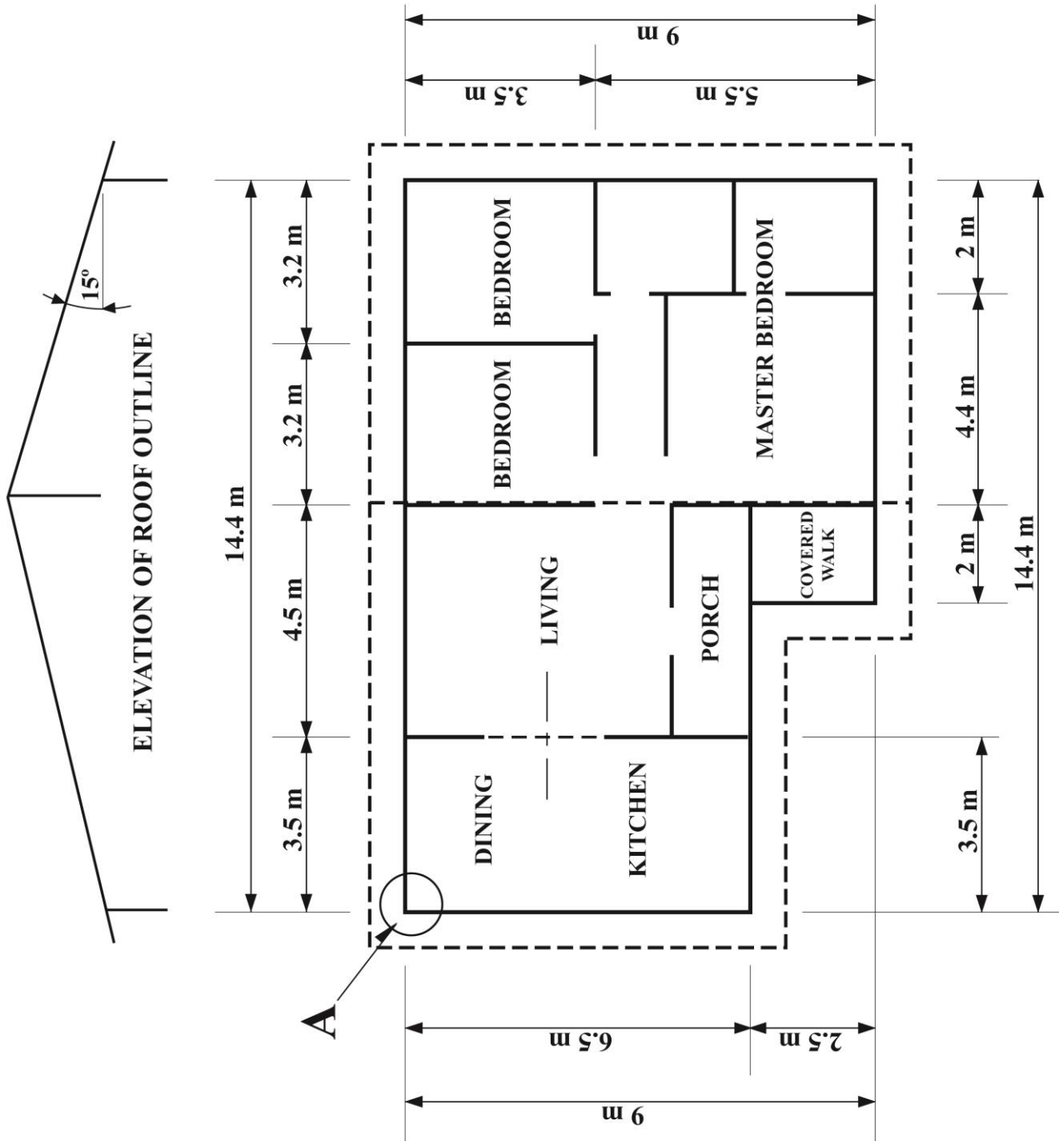

Figure 1

GO ON TO THE NEXT PAGE

(a) Sketch and label the foundation detail as at 'A' showing clearly:

- (i) 600 mm strip footing with reinforced concrete
- (ii) 200 mm floor slab
- (iii) Hardcore
- (iv) Sand screed
- (v) PVC damp proofing

[Total 30 marks]

END OF TEST



C A R I B B E A N E X A M I N A T I O N S C O U N C I L

CARIBBEAN SECONDARY EDUCATION CERTIFICATE®
EXAMINATION

TECHNICAL DRAWING

BUILDING DRAWING

PAPER 02 – GENERAL PROFICIENCY

SOLUTIONS AND MARK SCHEME

SPECIMEN PAPER 2015

Note: Scoring methods used are the global/holistic method and analytical method.

TECHNICAL DRAWING
BUILDING DRAWING
PAPER 02
SOLUTIONS AND MARK SCHEME

QUESTION	KNOWLEDGE	MARKS	APPLICATION	MARKS	PRACTICAL ABILITY	MARKS
1.	<p>Knowledge of:</p> <ul style="list-style-type: none"> - Roof framing plan: <ul style="list-style-type: none"> • Plan outline • Roof members (ridge, rafters, laths, wall plate) • Eaves - Dimensions - Labelling - Scale 	9	<p>Principles of:</p> <ul style="list-style-type: none"> - Roof plan - Drawing roof plan to a scale of 1:50 - Representation of framing plan <ul style="list-style-type: none"> • Plan outline • Roof framing members (ridge, rafters, laths, wall plate) - Dimensioning - Labelling 	8	<p>Accuracy of:</p> <ul style="list-style-type: none"> - Roof plan - Dimensions - Dimensioning technique - Completed roof plan to include: <ul style="list-style-type: none"> • Plan outline • Roof framing members (ridge, rafters, laths, wall plate) • Eaves <p>Printing:</p> <ul style="list-style-type: none"> - Labelling - Title - Scale - Neatness/CAD presentation - Line work/line type 	8 6 4 9
		18		36		36

TECHNICAL DRAWING
BUILDING DRAWING
PAPER 02
SOLUTIONS AND MARK SCHEME

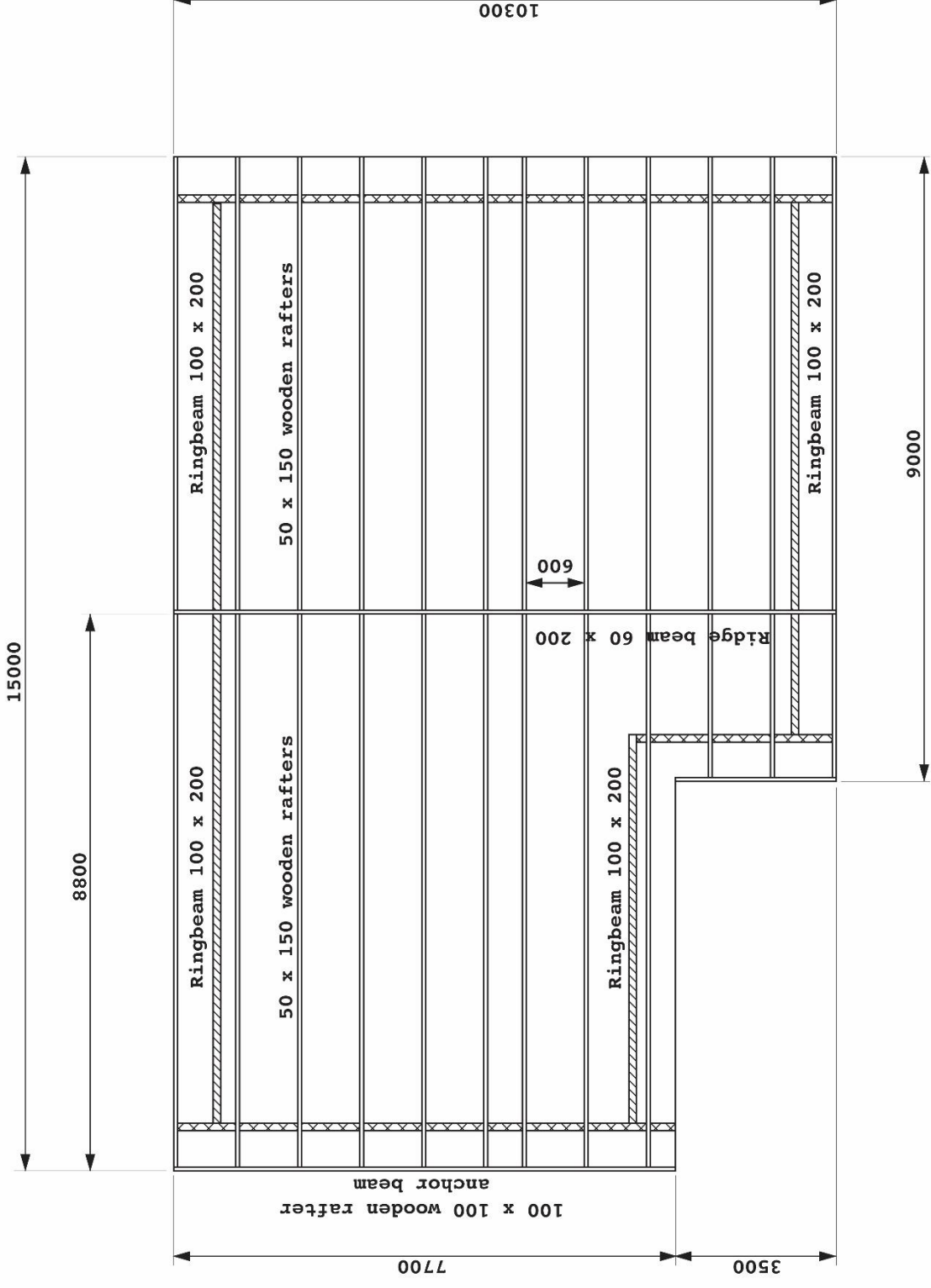

NOTE

Close board roof: Sheet board
screwed to rafter

Open roof: Laths screwed to
rafter every 600 c/c

ROOF FRAMING PLAN
SCALE: 1:50

ROOF FRAMING PLAN

TECHNICAL DRAWING
BUILDING DRAWING
PAPER 02
SOLUTIONS AND MARK SCHEME

QUESTION	KNOWLEDGE	MARKS	APPLICATION	MARKS	PRACTICAL ABILITY	MARKS
2	<p>Knowledge of:</p> <ul style="list-style-type: none"> - Foundation - Foundation footing details <ul style="list-style-type: none"> • Reinforced concrete footing • Floor slab • Sand screed • Hardcore • PVC damp proofing 	2 4	<p>Principles of:</p> <ul style="list-style-type: none"> - Foundation - Representation of foundation footing details <ul style="list-style-type: none"> • Reinforced concrete footing • Floor slab • Sand screed • Hardcore • PVC damp proofing - Proportion 	3 6	<p>Accuracy of:</p> <ul style="list-style-type: none"> - Foundation detail - Representation of footing details - Proportion - Neatness/CAD presentation 	3 6 2 2
		6		11		13

TECHNICAL DRAWING
 BUILDING DRAWING
 PAPER 02
 SOLUTIONS AND MARK SCHEME

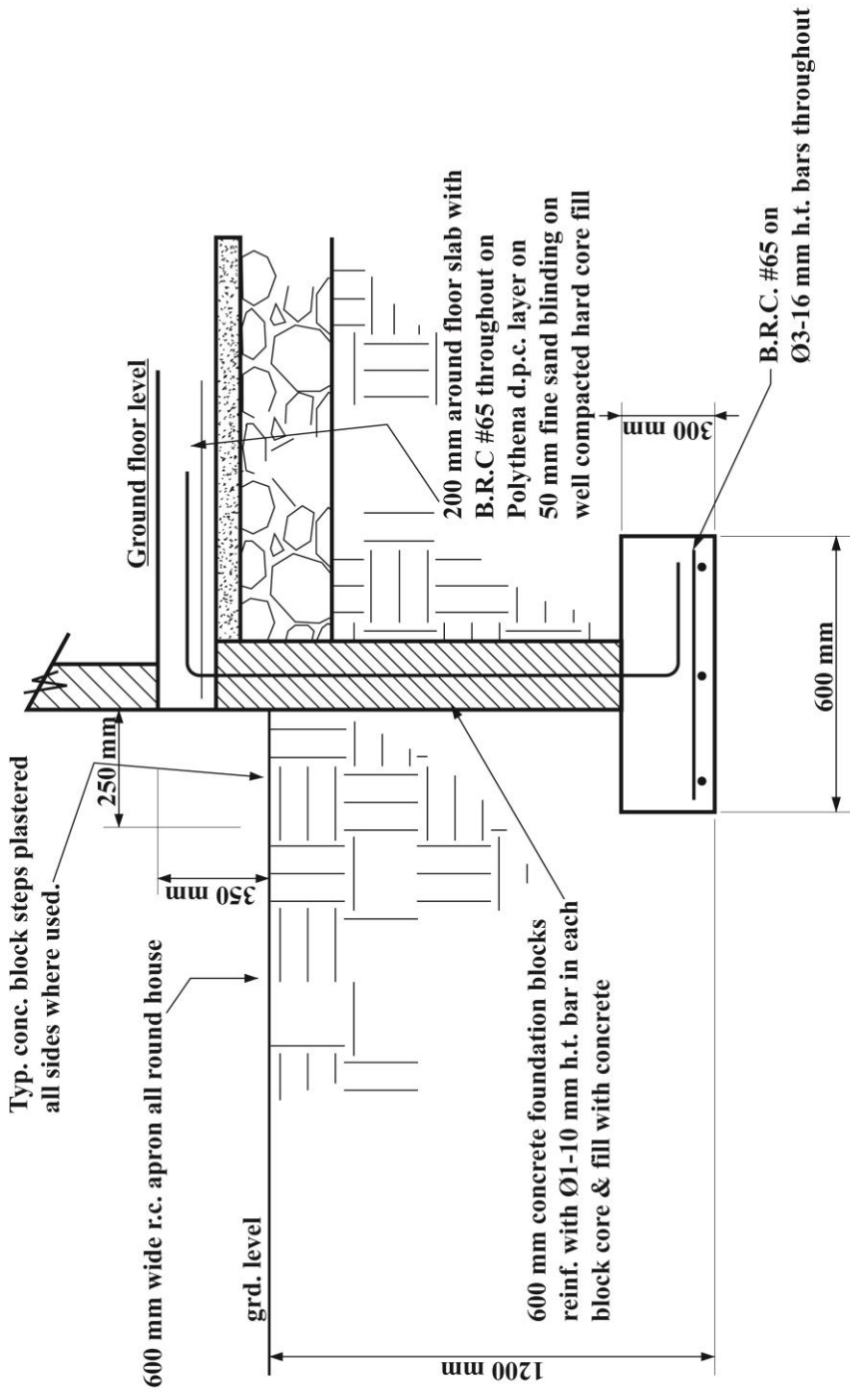

FOUNDATION DETAIL AT 'A'



Caribbean Examinations Council
Prince Road, Pine Plantation Road,
St Michael BB11091
Tel: (246) 227 1700
Email: cxezo@cxc.org